



Exam : 642-072

Title : Cisco Unity Design and Networking

Ver : 10-04-07

QUESTION 1:

When installing Cisco Unity into a Lotus Domino messaging environment, one requirement is to install at least one Cisco Unity server per Domino _____.

- A. nsf group
- B. domain
- C. site
- D. routing group

Answer: B

QUESTION 2:

Some Cisco Unity Unified Messaging users complain that they cannot make a TRaP connection when attempting to play and record messages through their desktops. What is a possible cause of this?

- A. The Cisco Unity server does not have a sufficient number of Unified Messaging licenses.
- B. These users need to have their Exchange mailboxes modified to allow access.
- C. These users are not licensed for Unified Messaging.
- D. A firewall separates these users from Cisco Unity.

Answer: D

QUESTION 3:

Certkiller .com sells wireless communications services to customers throughout the eastern United States. In 1999, Certkiller .com acquired a smaller wireless communications company, Snafu inc. Snafu inc provides similar services to Certkiller .com in the New England area. Certkiller .com has its headquarters in Dulles, Virginia (3253 employees) and its branch offices are located in Richmond, Virginia (1131 employees), Baltimore (748 employees), Washington, D.C. (442 employees), Philadelphia (115 employees), and Trenton, New Jersey (26 employees). Snafu inc has its headquarters in New York City (414 employees), and its branches are in Boston (212 employees) and Providence, Rhode Island (89 employees). Certkiller .com will be implementing a centralized Cisco Unity deployment. When customers call an employee, the company wants to provide quick service on those directory lookups.

Which implementation does the best job of delivering the service?

- A. Build multiple directory handlers that break the company population into groups arranged alphabetically by last name; make four groups as equal as possible in size; build an introductory call handler from the opening greeting that provides one-key dialing to each of the four groups.

- B. Buy a Platform Overlay 3 server with extra memory and processor speed to provide the quickest service.
- C. Build a directory handler for each office; put each subscriber in a distribution list for that office; make that list limit the directory handler search; build an introductory call handler from the opening greeting that provides one-key dialing to each of the offices.
- D. Build two directory handlers: one for Certkiller .com, and one for Snafu inc; add subscribers to the appropriate subscriber template and use that template to limit the directory search; build an introductory call handler from the opening greeting that provides one-key dialing to each of the directory handlers.

Answer: C

QUESTION 4:

Exhibit:

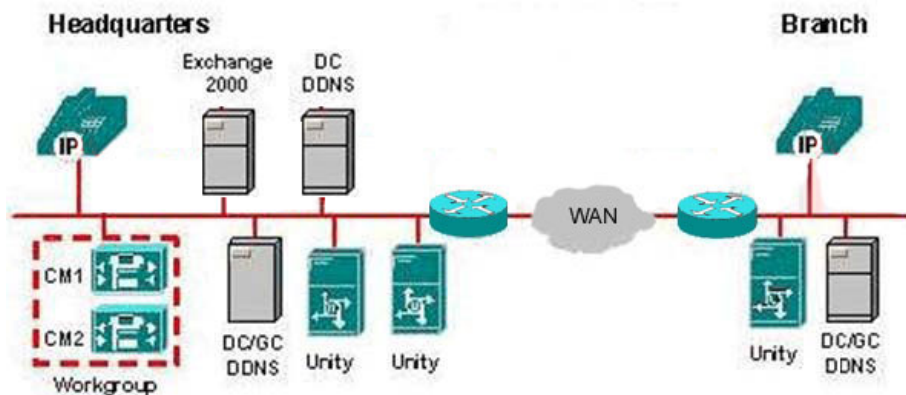

Please study the exhibit carefully. Which messaging deployment model is shown?

- A. clustered Exchange messaging
- B. branched messaging
- C. This is not a supported message deployment model.
- D. distributed messaging

Answer: C

QUESTION 5:

Certkiller .com is concerned about security on their Cisco Unity Unified Messaging installation. Which two steps can they take to improve security? (Choose two.)

- A. Keep voice-mail messages on the box.
- B. Install Cisco Security Agent for Cisco Unity.
- C. Isolate Cisco Unity behind a separate firewall.
- D. Install antivirus software.
- E. Perform a nightly backup.

Answer: B,D

QUESTION 6:

You are designing a Cisco Unity voice-mail-only solution to allow all outside callers at any of the 14 different company offices to locate any of the 7500 users by simply spelling the name of the user via the touch-tone telephone keypad in an Automated Attendant conversation. Each office has a different voice-mail system that you will replace with the new Cisco Unity solution. Each office also has a separate telephone system. The telephone systems come from various manufacturers. Users dial individual 10-digit phone numbers to reach each user. There is no telephone networking between offices. Many of the telephone systems will not allow conferencing and have a limited number of trunks for each office. Certkiller .com is not willing to change the telephone system structure at this time.

Which solution best meets Certkiller .com needs?

- A. This can be done with VPIM, which is an industry standard that allows different telephone systems to integrate over the Internet.
- B. You can network the Cisco Unity systems together for subscriber-to-subscriber messaging, but to fulfill the requirements they want for Automated Attendant transfers between offices, they need to change to a networked telephone system solution.
- C. Create a new forest/domain and add one Cisco Unity server at each office. All Cisco Unity systems are member servers in the forest/domain and are provisioned for the number of users at that site. On one Cisco Unity server a dialing domain is created and all other Cisco Unity servers join that dialing domain. The directory handler search scope is set to that dialing domain.
- D. This can be done with the optional Cisco Unity PBX conference feature that allows transfers between different PBXs by using the Intel Dialogic voice cards installed in all Cisco Unity servers.

Answer: B

QUESTION 7:

During the presales phase of the design process, which design template do you use to ensure you understand Certkiller .com goals?

- A. customer requirements verification
- B. customer expectation validation
- C. customer needs statement
- D. customer feature and function list

Answer: A

QUESTION 8:

As part of the design acceptance process your Domino customer has asked that you give

a brief description of the integration between mailstore, the Cisco Unity server, and client workstation. You explain the concept of how the different components of the Domino Communication Services will be installed on each of the different servers. Select the statement that is the accurate explanation.

- A. There are three DUC services: CS Server, which is installed on the server storing user mailboxes; CS Admin, which is installed on the Domino Administrator server; and CS client, which is installed on the client workstation and the Cisco Unity Server. The Domino CS client software installed on the Cisco Unity server allows access to inbox status to see new voice-mail messages, so Cisco Unity can light the lamps on the correlating phones of users.
- B. There are three DUC services: CS server, which is installed on the Cisco Unity Server; CS Admin, which is installed on the Domino server, storing inboxes of users; and CS client, which is installed on the client workstation. Domino client software is also installed on the Cisco Unity server. Cisco Unity uses the client to send mail to users and view who has new voice-mail messages, so Cisco Unity can light the lamps on the correlating phones belonging to users.
- C. There are three DUC services: CS Server, which is installed on the server, storing user mailboxes; CS Admin, which is installed on the Domino Administrator server; and CS client, which is installed on the client workstation. Domino client software is installed on the Cisco Unity server. Cisco Unity uses the client to send mail to users and the Domino server sends Cisco Unity updates on who has new voice-mail messages, so Cisco Unity can light the lamps on the correlating phones belonging to users.
- D. There are three DUC services: DOMDUC server, which is installed on the server, storing user mailboxes; DOMDUC Admin, which is installed on the Domino Administrator server, and DOMDUC client, which is installed on the client workstation. Domino client software is installed on the Cisco Unity server. Cisco Unity uses the client to view inboxes belonging to users to see who has new voice-mail messages, so Cisco Unity can light the lamps on the correlating phones of users.

Answer: C

QUESTION 9:

You are beginning the Cisco Unity design process with Certkiller .com. Which worksheet template do you use first?

- A. external customer requirements
- B. preliminary customer requirements interview
- C. initial customer requirements
- D. internal customer requirements

Answer: D

QUESTION 10:

Cisco Unity is installed in a voice-mail-only configuration using the existing messaging infrastructure. Certkiller .com is now ready to move to Unified Messaging. Which utility can move the attributes of the voice-mail boxes?

- A. Move User Data tool
- B. Migrate Subscriber Data tool
- C. Grant Unity Access utility
- D. Bulk Import utility

Answer: B

QUESTION 11:

You are conducting a physical site survey. What two items require data collection? (Choose two.)

- A. What type of work is done on site?
- B. Are there any messaging servers on site?
- C. How many managers are on site?
- D. How many users are on site?
- E. How many offices are on site?

Answer: B,D

QUESTION 12:

Domino Unified Communications Services must be installed on which servers in a Cisco Unity for Lotus Domino messaging environment?

- A. all Cisco Unity servers in the domain
- B. all Lotus Domino servers in the domain
- C. Lotus Domino servers hosting Cisco Unity subscribers
- D. only the Cisco Unity Partner Domino server

Answer: C

QUESTION 13:

Which Cisco Unity component does VERITAS Backup Exec back up that the Cisco Unity Disaster Recovery Tool does not?

- A. off-box messages
- B. routing rules
- C. operating system
- D. SQL database

Answer: C

QUESTION 14:

Certkiller .com is almost finished migrating from a Cisco Unity interoperability system with an Octel solution. They have a technician on-site to replace another Octel node with a Cisco Unity server. Certkiller .com calls and asks what tool you used last time to add all the Bridge subscribers from an Excel file, and where it is. Select the utility name and location.

- A. Migrate Subscriber Data tool in Tools Depot
- B. Bulk Import in the Commserver/Techtools folder
- C. Migrate User Import utility in Tools Depot
- D. Bridge User Import in the Commserver/Bridge Migrations folder

Answer: A

QUESTION 15:

Certkiller .com has two locations with different messaging infrastructures. How would you gather the specific information needed to create a good design?

- A. Redefine for Certkiller .com how both sites will function after you implement your design.
- B. Perform the messaging and telecommunications interviews.
- C. Treat each site separately and provide a separate solution for each.
- D. Perform the physical site and logical site survey.

Answer: D

QUESTION 16:

You are conducting a site survey for a Unified Messaging customer. Which statement is true in regard to the information which should be gathered during a site survey?

- A. Since the location of the domain controller/global catalog servers does matter you will need it, as well as the manufacturer, model, and software version number of the PBX, and mailstore information.
- B. Since the location of domain controller/global catalog servers does not matter for a Unified Messaging installation, you need only the manufacturer, model and software version number of the PBX and the mailstore information.
- C. Since the Cisco Unity server will be the domain controller/global catalog servers for a Unified Messaging installation, you need only the manufacturer and model of the PBX, and mailstore information.
- D. Since the location of domain controller/global catalog servers does not matter in a

Unified Messaging installation, you will need only the manufacturer, model, and software version number of the PBX, and no mailstore information.

Answer: A

QUESTION 17:

In which messaging configuration must the schema be extended for Cisco Unity?

- A. Domino/Exchange mixed-mode
- B. Exchange 2000/2003
- C. Exchange 5.5
- D. Lotus Domino

Answer: B

QUESTION 18:

Exhibit:

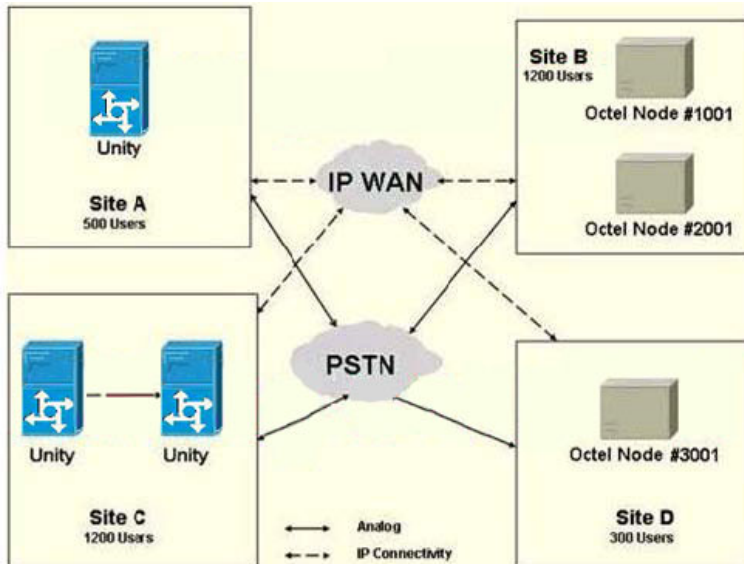

Please study the exhibit carefully. How many Bridge delivery locations must be configured in the Cisco Unity Bridgehead server?

- A. 3
- B. 1
- C. 4
- D. 2

Answer: A

QUESTION 19:

You have completed the low-level design definition document. What is the next document step in the process?

- A. logical site survey
- B. Bill of Materials
- C. implementation plan
- D. physical site survey

Answer: C

QUESTION 20:

By default, Cisco Unity interacts with which directory file in Lotus Domino?

- A. AdSchema.dat
- B. Domain.nam
- C. Directory.dir
- D. Names.nsf

Answer: D

QUESTION 21:

Certkiller .com has a 10,000-user voice-mail-only deployment. The TDM phone system (not a Cisco Unified CallManager) that supports all the users is located in the Southern regional office and the telephone system integration uses a serial connection. You have requested space for the Cisco Unity servers and they have assigned space in the Northern regional office with the data servers. The bandwidth between the Southern and Northern regional offices is dial-up via analog lines. Which statement is true?

- A. This solution will work; the phone system and the voice-mail system can use the analog dial-up connection to communicate with each other.
- B. This solution will not work; you must have the phone system and the voice-mail system in the same location, or enough bandwidth to use the remote PIMG option.
- C. This solution will not work; you must provide T1-level bandwidth to redirect the serial integration data.
- D. This solution will work; the phone system and the voice-mail system do not need to be in the same location.

Answer: B

QUESTION 22:

Certkiller .com is replacing their voice-mail system with a Cisco Unified Messaging system. They have 2000 employees. They have recently deployed a Cisco Unified CallManager cluster. The features they must continue to have are:

1. New voice-mail notification to cellular phones and SMS pagers.
 2. The voice-mail messages must be saved with the Exchange server backup.
 3. Voice-mail messages must be able to be marked urgent by the outside caller.
 4. The ability to create distribution lists that notify everyone in a department but give the message to only the first user to call in; all others get a prompt stating the message was delivered to "the first user name."
 5. 96 ports of voice mail/Auto Attendant.
 6. Outside callers must be able to reach users by spelling the name of the user using the "3-push method" for typing a name on the telephone keypad; for example, the letter B is typed by pushing the number 2 twice in a row.
- Certkiller .com needs to know which features and functions will be different with the new Cisco Unity as compared to the old voice-mail system. Which features will continue to function the same way in the new Cisco Unity?

- A. 1326
- B. 1235
- C. 2456
- D. 1346

Answer: B

QUESTION 23:

You are planning to deploy a voice-mail-only solution with a migration path to Unified Messaging. You are establishing Cisco Unity in your own forest/domain. What is the Cisco Unity best-practice recommended Exchange alias naming convention?

- A. Firstname.Lastname
- B. anything except what already exists or is planned
- C. Lastname.Firstname
- D. Match what already exists or is planned.

Answer: D

QUESTION 24:

Certkiller .com has Cisco Unity installed in a voice-mail-only configuration. Some users want to have the ability to check their voice-mail messages from their desktops and do not want to wait until the Unified Messaging migration to do so. Which two options can you offer them? (Choose two.)

- A. Viewmail for Outlook
- B. Unity Message View for Exchange
- C. IMAP 4 connectivity
- D. Unity Message Monitor
- E. Unity Inbox

Answer: C,E

QUESTION 25:

Certkiller .com has stated that they need a Unified Messaging solution that will provide unified messaging for 3000 users in one office in Peru and voice mail for an additional 2000 traveling salespeople throughout North and South America. The telephone infrastructure is a large Cisco Unified CallManager cluster and all voice-mail storage is in the main office. When a caller is identified as a particular user, the Cisco Unity system must speak to them in the caller's language. To find out if you can meet these requirements, what initial information would you need to gather?

- A. which mailstore they are using and what language they need Cisco Unity to speak
- B. which mailstore they are using, how many languages and which languages they need Cisco Unity to speak
- C. which mailstore they are using and on what type of servers they have the mailstore loaded
- D. which telephone numbers they are using to call voice mail, and how many languages they need Cisco Unity to speak

Answer: B

QUESTION 26:

Certkiller .com has ten offices across the country with Octel voice messaging systems in each. They need a voice-mail-only solution that will not impact the current Active Directory they are using. As part of your design you need to add a migration path to get them from a Cisco Unity and Octel interoperability solution to use only a Cisco Unity solution. They plan to change one office to Cisco Unity every three months, but they must have the ability to send and receive messages between users in all offices at all times. They use Octel analog networking between the offices now. They want to start with the Nebraska site.

Select two statements that offer the best choice for migrating from Octel to a complete Cisco Unity solution according to the design process. (Choose two.)

- A. Gather the Octel serial numbers, Octel node IDs, telephone numbers, and user extensions for each office. Install Cisco Unity and a Cisco Unity Bridge in Certkiller .com current Active Directory forest, then use the Nebraska office Octel serial number and dial ID for the Cisco Unity and Unity Bridge primary location information. Create delivery locations on Cisco Unity using the Octel dial IDs and telephone numbers you gathered from each office. Install the users for the Nebraska office. Disconnect the Nebraska office Octel server and connect the Cisco Unity server. Force name net emulation to replicate the user database. In three months repeat these steps at the next office.
- B. Create a new forest and new dial plan for all Octel node IDs and users. Install Cisco Unity and a Cisco Unity Bridge in the new Active Directory forest, then create a new

serial number and dial ID for the Cisco Unity and Unity Bridge primary location information. Create delivery locations to Cisco Unity using the Octel dial IDs from your new dial plan for each office. Install the users for the Nebraska office. Force name net data synchronization to replicate the user database. In three months repeat these steps at the next office.

C. Gather the Octel serial numbers, Octel node IDs, telephone numbers, and user extensions for each office. Install Cisco Unity and a Cisco Unity Bridge in Certkiller .com current Active Directory forest, then create a new serial number and dial ID for the Cisco Unity and Unity Bridge primary location information. Create delivery locations on Cisco Unity using the Octel dial IDs and telephone numbers you gathered from each office. Install the users for the Nebraska office. Force name net emulation to replicate the user database. In three months repeat these steps at the next office.

D. Disconnect the Octel system and connect the Cisco Unity system.

E. Gather the Octel serial numbers, Octel node IDs, telephone numbers, and user extensions for each office. Install Cisco Unity and a Cisco Unity Bridge in a new Active Directory forest separate from Certkiller .com current forest. Use the Nebraska office Octel serial number and dial ID for the Cisco Unity and Unity Bridge primary location information. Create delivery locations on Cisco Unity using the Octel dial IDs and telephone numbers you gathered from each office. Install the users for the Nebraska office. Force synchronization through the Bridge server to replicate the user database. In three months repeat these steps at the next office.

Answer: D,E

QUESTION 27:

Exhibit:

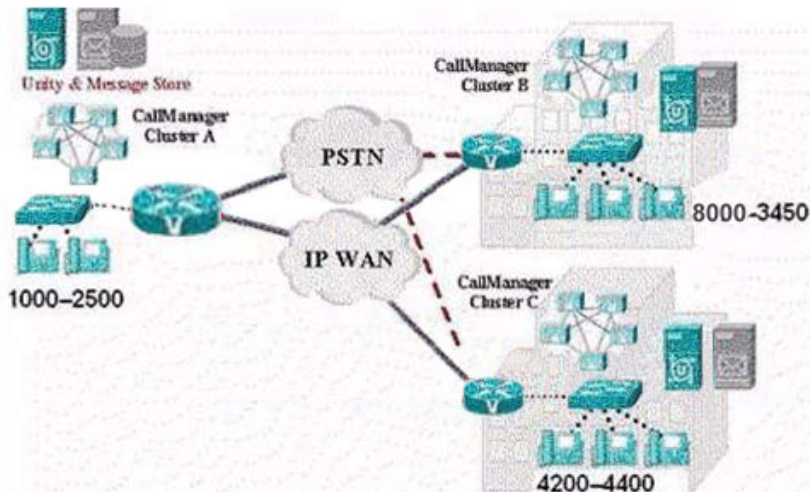

Please study the exhibit carefully. Cisco Unified CallManager cluster A and Unity A use extension range 1000-2500. Cisco Unified CallManager cluster B and Unity B use extension range 3000-3450. Cisco Unified CallManager cluster C and Unity C use extension range 4200-4400. Certkiller .com wants to deploy Unified Messaging. Exchange stores are local at each site and part of the same organization. Digital networking without using access codes is an absolute requirement, and callers need to be

able to use the Cisco Unity Auto Attendant to reach any user at any site.
Which statement is true?

- A. To deploy Unified Messaging, you need three separate dialing domains.
- B. Cisco Unity servers A and B are in the same dialing domain and Cisco Unity C uses extension masking to address any extension conflicts with them.
- C. Configure all Cisco Unity servers into the same dialing domain and each Cisco Unity call handler search scope to that dialing domain.
- D. All Cisco Unity servers will recognize each other via Active Directory. The Cisco Unified CallManager will handle any overlapping dial plan with partitions and calling search spaces.

Answer: C

QUESTION 28:

The Cisco Unity Voice Connector performs which task on an outgoing VPIM message?

- A. stores the message in the VPIM mailbox
- B. converts the outgoing message to G.726
- C. converts the message to MAPI format
- D. sets the address type to VOICE

Answer: B

QUESTION 29:

A company plans to implement the Cisco Unity Unified Messaging solution over the coming months. The Cisco Unity system will be installed at the main office and will integrate with Cisco Unified CallManager V5.0. It must work with the existing VPIM-compatible voice-mail systems at the three branch locations until they are converted to Cisco Unity, one at a time. Cisco Unity will be using a centralized call-processing and a centralized messaging-deployment model. There are 75 employees at each branch location. The IT department expects the process to take three months. They want all subscribers and outside callers to be able to address voice messages to all employees as soon as Cisco Unity is implemented.
What is the best way to accomplish this goal?

- A. All main office employees are created as Cisco Unity subscribers and all branch office employees are created as VPIM subscribers. Branch employee accounts are rebuilt, one at a time, into Cisco Unity subscribers.
- B. All employees are created as Cisco Unity subscribers, calls are automatically transferred and voice messages are automatically forwarded to subscribers at the branch locations. No conversion is necessary when the branch locations are brought online.
- C. Main office employees are created as Cisco Unity subscribers and all branch office employees are created as VPIM subscribers. At the appropriate time, the Migrate

Subscriber Data tool is used to convert the branch employee accounts.

D. All main office employees are created as Cisco Unity subscribers and all branch office employees are created as VPIM subscribers. At the appropriate time, the Bulk Subscriber Import tool is used to convert the branch employee accounts.

Answer: C

QUESTION 30:

Exhibit:

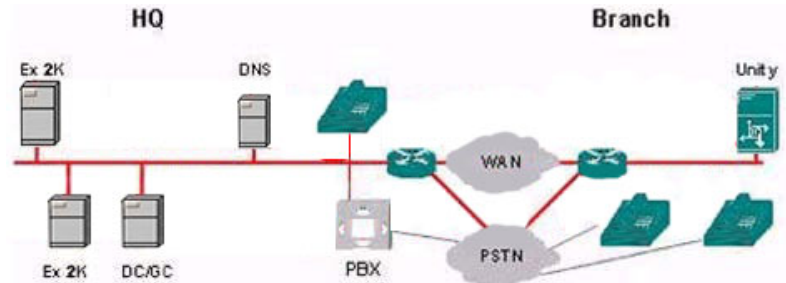

Please study the exhibit carefully. Which type of Cisco Unity deployment model is shown?

- A. The exhibit does not show a valid model combination.
- B. distributed call processing, distributed messaging
- C. centralized call processing, distributed messaging
- D. localized call processing, localized branch messaging

Answer: A

QUESTION 31:

You have Certkiller .com who is just starting the migration from a Cisco Unity solution that features Octel interoperability. They are on the first site to have the Octel server replaced with a Cisco Unity solution. The setup and configuration is done but there is a problem with message delivery to the Octel nodes. The administrator for the old site gave your technician incorrect Octel Node IDs. There are over 60 different Octel nodes. Your technician has asked if there is a utility to make the ID changes all at once or if the Cisco Unity System administrator must go through one delivery location at a time. Select the correct statement.

- A. Use the Bulk Import tool from Tools depot.
- B. Use the Cisco Unity system administrator. There is no utility that allows modification of delivery locations
- C. Use the Cisco Unity system administrator. There is a separate utility that allows modification of delivery locations, but it was not purchased by Certkiller .com.
- D. Use the Delivery Location Import and Change tool in the Commserver/Techtools folder.

Answer: A

QUESTION 32:

Jack@ Certkiller .com is an email alias for a user at a site where only Cisco Unity voice mail will be installed. The company intends to move to Unified Messaging within the year. They have decided to add Cisco Unity as a member server in the existing forest/domain for the company.

What, if anything, needs to be changed or added concerning the Jack@ Certkiller .com email alias with the installation of the voice-mail-only system?

- A. A new account, VM-Jack@ Certkiller .com, should be added.
- B. A new account, VM-Jack@ Certkiller .com, should be added and hidden in the global address book.
- C. A new account, Jack@vm- Certkiller .com, should be added and hidden in the global address book.
- D. A new account, Jack@vm- Certkiller .com, should be added.

Answer: B

QUESTION 33:

Certkiller .com is seeking proposals to replace their voice-mail system with a Unified Messaging system, which is to be coordinated with their Exchange 2003 rollout. They have 2000 employees at their headquarters location, 800 employees at their data center, and 1000 employees at their 80 branch locations. Headquarters has redundant OC-3 connections to the data center and is using a Nortel PBX. They have recently deployed a Cisco Unified CallManager cluster at the data center, which provides centralized call processing for the branch locations. The Unified Messaging system must provide call answering and MWI for the IP phones and the existing Nortel PBX. Certkiller .com has a corporate policy that all server resources must be located at the data center when possible. Your preliminary design calls for a Cisco Unity server at the data center that will integrate with the new Exchange 2003 servers to provide unified messaging for all employees.

Which two should be included in your preliminary design to make this a Cisco-supported design? (Choose two.)

- A. Global Catalog server dedicated for Cisco Unity
- B. Active Directory forest dedicated for Cisco Unity
- C. Partner Exchange server at headquarters
- D. Cisco Unity server at headquarters
- E. Active Directory server dedicated for Cisco Unity

Answer: B,C

QUESTION 34:

Certkiller .com has 1200 users. The users are spread evenly across three routing groups in one Exchange 2000 organization. Each routing group is in a different geographical location within a single phone system. You need to configure a voice-mail-only solution with a plan to migrate to unified messaging. They must have the ability to send an all-employee message to one distribution list and have the Automated Attendant search for all users by name regardless of the location. Which configuration meets Certkiller .com requirements?

- A. a new forest/domain with one Cisco Unity system in the existing root Exchange routing groups
- B. There is no Cisco Unity solution that fits this Exchange 2000 configuration.
- C. a new forest/domain with three Cisco Unity systems in each new Exchange routing group
- D. a new forest/domain with one Cisco Unity system in each new Exchange routing group

Answer: D

QUESTION 35:

The Grant Unity Access utility is used when subscribers have authentication issues using the Cisco Unity Inbox in which Cisco Unity configuration?

- A. voice-mail-only configuration when Cisco Unity is installed in a new forest/domain
- B. voice-mail-only configurations when Cisco Unity is installed in the existing forest/domain
- C. all Unified Messaging configurations
- D. all voice-mail-only configurations

Answer: B

QUESTION 36:

Which statement about the DiRT backup is true?

- A. It can be restored to a functioning Cisco Unity of the same software level.
- B. It can be restored to a Cisco Unity platform with the operating system and SQL installed.
- C. It can be restored to a functioning Cisco Unity of an upgraded software level.
- D. It can be restored to a Cisco Unity platform with only the operating system installed.

Answer: A

QUESTION 37:

Certkiller .com developed a preliminary Bill of Materials for a Cisco Unity voice-mail-only installation for their two locations. They will create a new forest/domain (VM.com) and use off-box Exchange message stores. Their Bill of Materials shows two Exchange servers and two Cisco Unity servers. They plan on using the domain controllers/global catalog servers in their existing domain for authentication. What do you tell Certkiller .com?

- A. The Bill of Materials is accurate.
- B. A domain controller/global catalog is needed in VM.com
- C. Cross-box authentication must be enabled on the Cisco Unity server.
- D. Certkiller .com should use on-box Exchange message store.

Answer: B

QUESTION 38:

Exhibit:

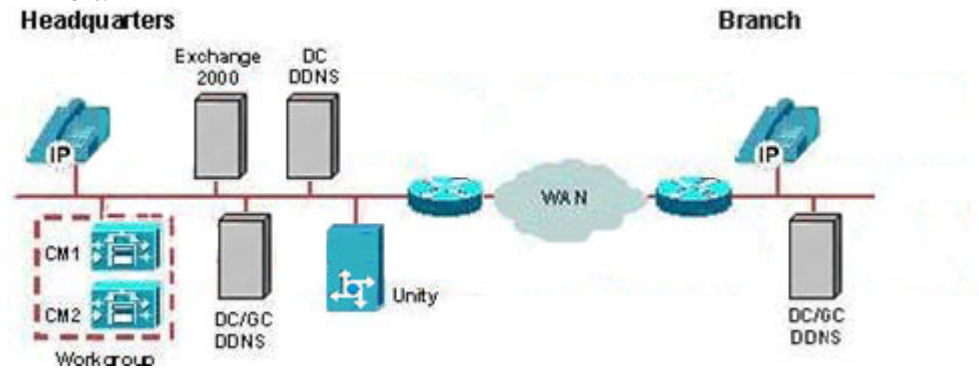

Please study the exhibit carefully. Which Cisco Unity messaging model is shown?

- A. centralized messaging
- B. distributed messaging
- C. clustered messaging
- D. branched messaging

Answer: A

QUESTION 39:

Exhibit:

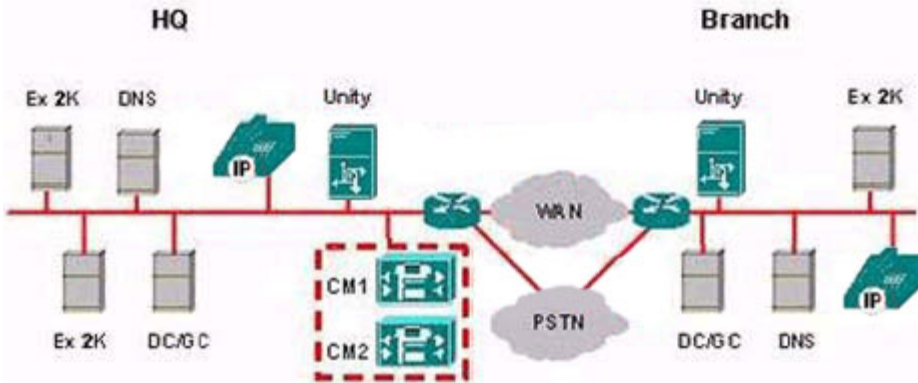

Please study the exhibit carefully. Which Cisco Unity deployment model is shown?

- A. localized call processing, localized branch messaging
- B. centralized call processing, distributed messaging
- C. distributed call processing, decentralized messaging
- D. centralized call processing, centralized messaging

Answer: B

QUESTION 40:

Exhibit:

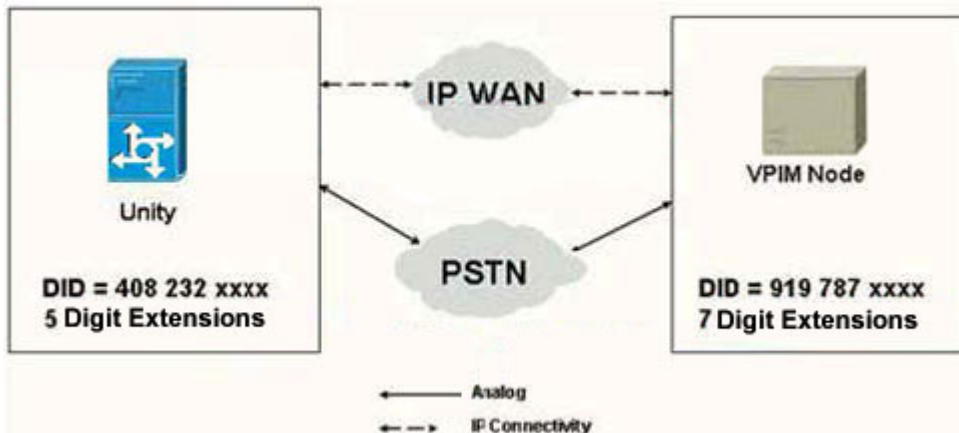

Please study the exhibit carefully. Certkiller .com needs to exchange voice messages with a supplier using VPIM. You are asked to provide "dial by name" and you want to maintain your internal 5-digit dialing plan. You add VPIM subscribers using a 5-digit extension and a 5-digit remote mailbox number. Because the voice-mail system of your supplier supports only blind addressing, they want to use the full DID number to send messages to you.

Which prefix should be configured in Cisco Unity server VPIM delivery location?

- A. Remote Cisco Unity Prefix=78
- B. Cisco Unity Prefix=40823
- C. Remote Cisco Unity Prefix=91978
- D. Cisco Unity Prefix=23

Answer: C

QUESTION 41:

You have completed the preliminary high-level design template. What is the next step in the design process?

- A. Create the preliminary low-level design.
- B. Create the job task assignment.
- C. Create a Bill of Materials.
- D. Create an implementation plan.

Answer: C

QUESTION 42:

You and Certkiller .com have completed the Cisco Unity usage analysis, physical site, and logical site design templates. What should be your next step?

- A. Create the Bill of Materials.
- B. Create the network requirements document.
- C. Create the high-level design.
- D. Create the low-level design.

Answer: C

QUESTION 43:

You are performing a site survey as part of your design process. Certkiller .com shows you seven large Microsoft Exchange servers but cannot tell you the version of the Exchange they are using. What is your next step?

- A. Continue with the site survey; you can get this information later.
- B. Continue with the site survey since you will not need this information.
- C. Stop the survey and show the person how to log in to the Exchange server and use the right-click option on the exchange Icon to show the version.
- D. Stop the site survey and request a new contact.

Answer: A

QUESTION 44:

Certkiller .com has a requirement of a voice-mail-only system with redundancy/failover to service their 10,000 users in locations across Europe. They plan to create a new forest/domain for the Cisco Unity installation with Exchange servers for off-box message

storage. They plan to install one Cisco Unity server with failover in Frankfurt, Berlin, and London. Telephone traffic at the London location at times exceeds the current Cisco Unity port capacity. They plan to use the failover server in London for overflow capacity. What do you tell Certkiller .com?

- A. This will work as planned.
- B. They need to purchase the license pooling feature.
- C. This will work if the SQL port synchronization feature is enabled.
- D. They need to install a second Cisco Unity server set in London.

Answer: D

QUESTION 45:

You are setting up VLANs for integration with IP telephony. Cisco Unity must reside on which VLAN?

- A. The voice VLAN is preferable, but not mandatory.
- B. In a voice-mail-only environment on the voice VLAN, in Cisco Unity Unified Messaging it does not matter.
- C. on the same VLAN as the messaging servers
- D. on the same VLAN as the Cisco Unified CallManager

Answer: C

QUESTION 46:

The Cisco Unity Internet Voice Connector performs which task on incoming VPIM messages?

- A. converts voice attachments to the G.729a audio format
- B. routes messages to the UOmni mailbox
- C. converts the message to MAPI format
- D. sets the address type to VOICE

Answer: C

QUESTION 47:

Exhibit:

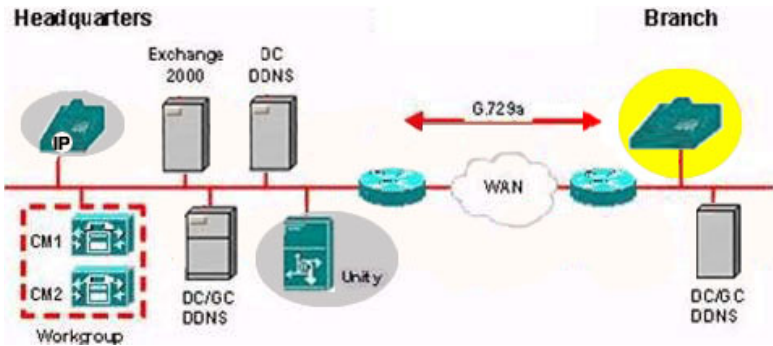

Please study the exhibit carefully. Certkiller .com has a remote branch with 50 telephones. There are no hardware transcoders on the routers. With the configuration as presented, which statement is true about codec use on the Cisco Unity?

- A. Cisco Unity should use G.729a for messages and G.711 for prompts.
- B. Cisco Unity codec must always be matched to Cisco Unified CallManager in centralized messaging deployments.
- C. Cisco Unity should be set to use G.729a.
- D. Cisco Unity should always use G.711 for messages.

Answer: C

QUESTION 48:

The storage of a 60-second Cisco Unity voice-mail message in Exchange using G.711 codec will require approximately how much message space?

- A. 1 MG
- B. 480 KB
- C. 180 KB
- D. 60 KB

Answer: B

QUESTION 49:

Certkiller .com has a Cisco Unity voice-mail-only configuration that has been installed in its own new forest/domain. Certkiller .com is ready to migrate to Unified Messaging. Which Cisco Unity utility will move the user mailboxes?

- A. Bulk Import Utility
- B. Disaster Recovery Tool
- C. Dump Subscriber Data
- D. Migrate Subscriber Data

Answer: B

QUESTION 50:

Certkiller .com had three physical site surveys and the following was determined: Site A has all the messaging servers for the entire company, and a Cisco Unity V4.2-supported TDM PBX and 300 users. Sites B and C have a Cisco Unity V4.2-supported TDM PBX, but not the same PBX as Site A, and both sites have 150 users. Certkiller .com needs unified messaging for the users at Site A, and they want the messaging servers at Site A to be the mailstore for the Unity server or servers. Select the true statement from the choices below.

- A. You will need three Cisco Unity servers; one at each site. You can use the mailstore at Site A, but Cisco Unity needs to be next to the TDM PBX to use PIMG units for integration.
- B. You will need two Unity servers: one for Site A, and one to cover the users at Sites B and C. Cisco Unity can integrate with only two PBXs at a time. You will need to install Exchange "on box" for the users at Sites B and C.
- C. You will need one Cisco Unity server at Site A. You will use PIMG units to integrate the three TDM PBXs. The Cisco Unity server will use the mailstore at Site A for all the users.
- D. You will need three Unity servers; one for each site. Cisco Unity can integrate with only one TDM switch and a CCM in dual integration mode. You will need to install Exchange "on box" for the users at Sites B and C.

Answer: C

QUESTION 51:

Certkiller .com has asked you about changes necessary to their circuit-switched PBX to accommodate the upcoming Cisco Unity Unified Messaging installation. Their telephone system will use a PIMG integration to Cisco Unity. Other than possibly requiring software reconfiguration on the telephone system and the installation of the PIMGs, what do you tell Certkiller .com?

- A. Voice boards must be installed in the Cisco Unity platform.
- B. The gateway must be physically close to the Cisco Unity for the RS-232 cable to reach.
- C. The telephone system requires enough analog line cards to support the gateway units.
- D. Digital phone ports are required in the telephone system to support the gateways.

Answer: D

QUESTION 52:

There are two Active Directory forests: Certkiller .com and Snafu.com. The Cisco Unified

CallManager cluster A and Unity A use extension range 1000-2500. The Cisco Unified CallManager cluster B and Unity B use extension range 3000-3450. Both sites A and B are in Certkiller .com. The Cisco Unified CallManager cluster C and Unity C use extension range 4200-4400. Site C is in Snafu.com. Certkiller .com wants to deploy unified messaging. Exchange stores are local at the sites. Digital networking without using access codes is an absolute requirement. What is the best solution?

- A. Site C needs to have all the servers reinstalled as part of Certkiller .com.
- B. A completely unique dialing location is created in Cisco Unified CallManager. Cisco Unity is assigned to that location.
- C. Future growth is accommodated by allowing all Cisco Unity servers to be in different forests, but to be part of the same dialing domain.
- D. A unique dialing domain is created per Cisco Unity location. There is no requirement for one directory.

Answer: A

QUESTION 53:

Exhibit:

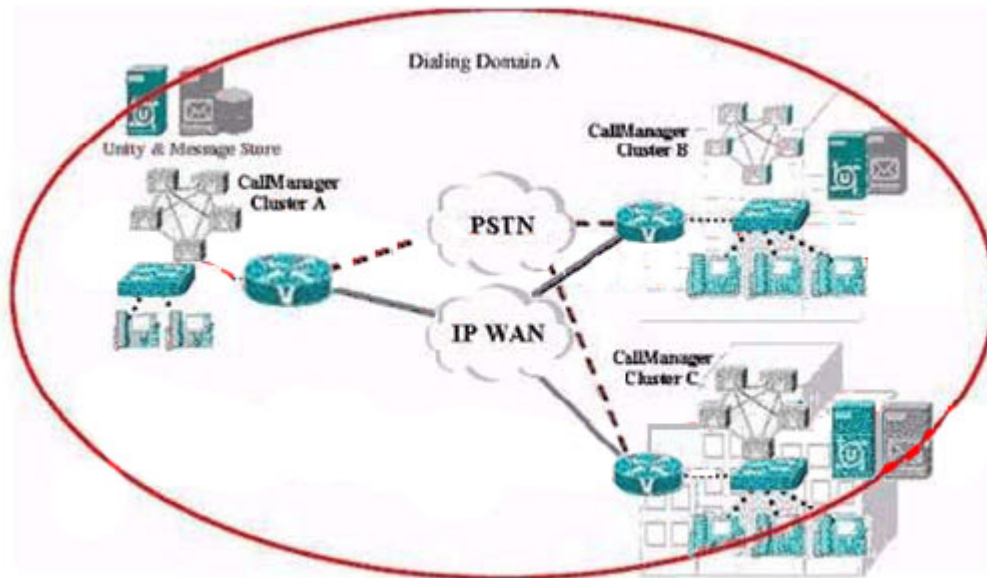

Please study the exhibit carefully. Cisco Unified CallManager cluster A and Unity A use extension range 1000-1650. Cisco Unified CallManager cluster B and Unity B use extension range 2000-2450. Cisco Unified CallManager cluster C and Unity C use extension range 1500-1950. Certkiller .com wants to deploy Unified Messaging. Exchange stores are local at each site and part of the same organization. Digital networking without using access codes is an absolute requirement. Which statement is true?

- A. A unique dialing domain is created per Cisco Unity location. The other Cisco Unity locations are automatically available at that time.
- B. Cisco Unity servers A and B are in the same dialing domain and Unity C is put into its

- own dialing domain to address the extension conflicts with Unity A and B.
- C. All Cisco Unity servers are in different locations, but are part of the same dialing domain.
 - D. All Cisco Unity servers are in the same dialing domain, and Cisco Unified CallManager cluster C needs to change the extensions that overlap with Cisco Unified CallManager cluster A.

Answer: D

QUESTION 54:

You are installing Cisco Unity in an Exchange 2000/2003 mixed-mode messaging configuration. Which Exchange server or servers can act as the mailstore?

- A. Exchange 2000 or 2003 servers
- B. Exchange 2003 servers only
- C. Exchange 2000 servers only
- D. Active Directory global catalog server

Answer: A

QUESTION 55:

Which is a feature of Domino Unified Communications Services?

- A. Message Waiting Indicators
- B. Directory Replication
- C. Call Control
- D. Message Forwarding

Answer: A

QUESTION 56:

Certkiller .com is concerned about the increase in storage space required for their users messaging inboxes with the installation of Cisco Unity Unified Messaging. Which codec or software can be used to minimize storage requirements?

- A. G.729a
- B. Exchange Optimizer
- C. G.726
- D. G.711

Answer: A

QUESTION 57:

Which is not a consideration when planning for capacity on the Cisco Unity servers?

- A. Authentication logon sessions
- B. Cisco Unity platform overlays
- C. Auto Attendant usage
- D. TRaP usage

Answer: A

QUESTION 58:

The Interop Gateway service is configured to run on which server or servers in an interoperability scenario?

- A. the Cisco Unity Bridgehead server in the IBM Lotus Domino configuration
- B. IBM Lotus Domino server or servers with Cisco Unity users
- C. IBM Lotus Domino servers where the DUC is installed
- D. all Cisco Unity servers in the IBM Lotus Domino configuration

Answer: A

QUESTION 59:

You are asked to consult on a Cisco Unity installation at Certkiller .com branch location. Users have slow access when they log on to Cisco Unity to retrieve their messages. At the branch location there are 2000 users on each of the two Cisco Unity servers and two Exchange servers. The call traffic is relatively low. There is never a time when all ports are busy on either Cisco Unity server. At headquarters there are two Cisco Unity servers, two Exchange servers, and a domain controller/global catalog server. How can you solve the issue at the branch location?

- A. A domain controller/global catalog server with name resolution should be added to the remote site for authentication.
- B. More fiber-optic-level bandwidth should be added between the Cisco Unity servers and the Exchange servers.
- C. The Exchange Optimizer application should be run on both messaging stores.
- D. An additional Exchange server should be added to the remote site.

Answer: A

QUESTION 60:

Certkiller .com has Cisco Unity installed in a distributed call-processing configuration. At their remote location, one of their two Cisco Unity Unified Messaging servers

experiences a catastrophic failure. Certkiller .com wants to use the recent Cisco Unity Disaster Recovery Tool backup to restore the failed server user database to the functioning Cisco Unity server. What do you tell Certkiller .com?

- A. VERITAS Backup Exec must be used in this scenario.
- B. The Disaster Recovery Tool will restore only to the default Cisco Unity database.
- C. This will work if all the user Exchange aliases are unique.
- D. This will work only if the user database does not exceed 7500 users on the functioning server.

Answer: B

QUESTION 61:

Certkiller .com is one of the world's largest brokerage firms. This corporation was founded in 1956 and is known for providing advanced communication services to its brokers, ensuring the fastest and most reliable communication. The company currently has over 10 million customers who trust them for the buying, selling, and trading of mutual funds, stocks, and precious metals.

The Company Headquarters (HQ) is located in Manhattan. It has offices in seven cities in the United States and five international cities. HQ has 3500 employees. Other U.S. locations include the Chicago office (1200 employees); Miami (450 employees); Boston (820 employees); Dallas (350 employees); Seattle (350 employees); and Los Angeles (1100 employees). International locations include Madrid (300 employees); London (200 employees); Paris (300 employees); Tokyo (450 employees); and Kuala Lumpur (500 employees).

The company uses Cisco routers, switches, firewalls, and intrusion detection, and has installed Cisco Unified CallManager clusters at all locations. The corporate network uses Microsoft Windows 2000 Active Directory.

There are two forests. The first forest has two root domains: coa.com and coa.internal.

The second forest root has only one domain: coaasia.com.

There are redundant domain controllers/global catalog servers at each location. DNS and DHCP servers are also found at each location. The HQ site has two OC-48 connections using HSRP. All sites have redundant T3s using HSRP to the HQ along with a T1 to every location, providing a fully meshed architecture. The company uses an Exchange 2000 messaging platform. There are no planned upgrades to Exchange 2003 at this time. There are two Exchange organizations: Org1 includes all North American and European servers and Org2 includes all Asian servers. Both organizations use a single routing group. Org2 has each city's Exchange servers in a unique administration group, while Org1 has a single administration group. Each office has local Internet connectivity, and each office maintains its own Exchange servers.

The company just upgraded to Cisco Unified CallManager at all locations. Two MCS 7835 servers are located at each site, except HQ, which has three MCS 7835 servers.

There are inter-cluster trunks established between all subscribers in all clusters.

The company likes the ability to route all intra-company calls over their 3DES encrypted network links. The existing voice-messaging platform was provided by several different

vendors and there is no networking between them. The company plans to change voice-messaging platforms at all locations to Cisco Unity. The system will initially be voice-mail-only, but will switch to Unified Messaging during the next fiscal year. Cisco Unity servers will be placed in each office.

Which kind of networking should be implemented to provide messaging among all the offices?

- A. VPIM networking must be implemented on all servers.
- B. Digital networking must be implemented on all servers, and Bridge networking must be implemented between the North American/European and Asian forests.
- C. Digital networking must be implemented on all servers.
- D. Digital networking must be implemented on all servers. VPIM networking must be implemented between the North American/European and Asian forests.

Answer: D

QUESTION 62:

Certkiller .com requires you to provide a Cisco Unity voice mail only solution today, with a planned migration path to Unified Messaging in the next year. They have an existing Windows 2000 and Exchange 2000 configuration that supports 12,000 users. At this time they do not allow the Windows Active Directory schema to be modified. How can you best meet Certkiller .com requirements?

- A. Create a separate forest/domain with new servers provisioned for the 12,000 users and use a separate Exchange alias naming convention so there are no overlapping GUID issues.
- B. Install two Cisco Unity servers in the existing Win2K domain and import the users.
- C. Create a separate forest/domain with new servers provisioned for the 12,000 users and use the same Exchange alias naming convention.
- D. Install four Cisco Unity servers in the existing Win2K domain and import the users.

Answer: C

QUESTION 63:

Certkiller .com maintains a wholly centralized Exchange messaging environment in a single data center located in Denver. Certkiller .com has a distributed Cisco Unified CallManager environment consisting of three separate clusters. These clusters support the Denver data center plus three large remote sites in Colorado Springs, Boulder, and Montrose. Certkiller .com plans to move from their centralized 10-year-old legacy voice-mail system to a Cisco Unity Unified Messaging system. Given Certkiller .com topology for call processing and messaging, what is your recommendation?

- A. You cannot provide an initial design at this time. Certkiller .com need for three Cisco Unified CallManager clusters has brought the design process to a standstill. Tell

Certkiller .com to fully collapse the Cisco Unified CallManager clusters for Cisco Unity to fit into their environment.

B. You recommend centralized and distributed Cisco Unity servers. There are many choices available to you because of the inherent call processing flexibility built in to a pure Cisco Unified CallManager design. You recommend a hybrid solution to demonstrate to Certkiller .com the flexibility of the product.

C. You recommend distributed Cisco Unity systems. Cisco Unity must reside as close as physically possible to the Cisco Unified CallManager clusters, and Cisco Unity servers must maintain a one-to-one relationship to the number of Cisco Unified CallManager clusters in the design. At a minimum you must provide a three Cisco Unity solution and the three solutions must be distributed to physically mirror the layout of the Cisco Unified CallManager topology.

D. You recommend centralized Cisco Unity systems. Cisco Unity must reside as close as physically possible to the message stores it will be servicing. Also, since Cisco Unity servers are capable of servicing more than one Cisco Unified CallManager cluster, you offer a centralized messaging and distributed call-processing design.

Answer: D

QUESTION 64:

You are attempting to manage subscribers on other Cisco Unity servers. When you attempt to connect, you are denied access. What is the probable cause?

A. The Cisco Unity server you are attempting to reach has the Cisco Security Agent for Unity installed.

B. You can use only Terminal Services for this function.

C. You do not have permissions and must run the Grant Unity Access utility.

D. You cannot manage Cisco Unity servers located outside your dialing domain.

Answer: C

QUESTION 65:

Place the following steps in the proper design process order:

1. Repeat Certkiller .com requirements back to them.

2. Create a Bill of Materials.

3. Gather information from Certkiller .com.

4. Define the ultimate customer goals.

5. Create a preliminary high-level design document.

A. 1 5 2 4 3

B. 5 3 4 2 1

C. 3 4 1 5 2

D. 1 2 4 3 5

Answer: C

QUESTION 66:

Exhibit:

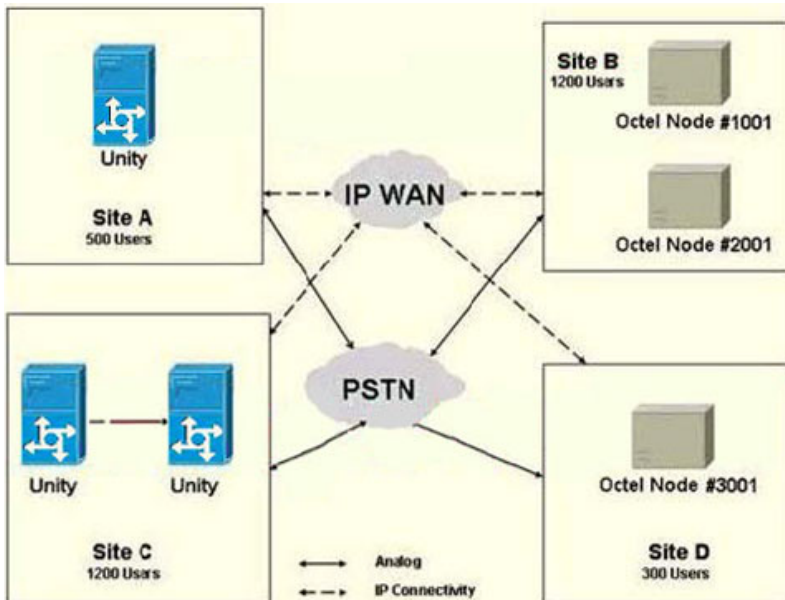

Please study the exhibit carefully. Certkiller .com deploys three Cisco Unity servers to provide messaging for their headquarters. They recently acquired Snafu inc, which has a networked Octel voice-mail system. Redundant OC-3 WAN connections have been provisioned for IP connectivity between all locations. You must interconnect the two voice-mail systems.

What is the best location for deploying the Bridge server?

- A. Site A
- B. Site B
- C. Site C
- D. Site D

Answer: B

QUESTION 67:

Exhibit:

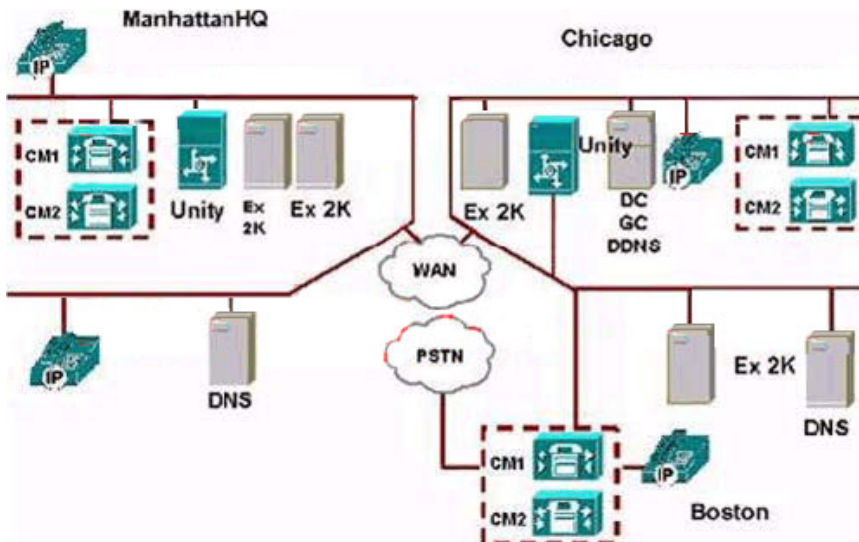

Please study the exhibit carefully. The exhibit shows a voice-mail-only installation plan. Does this plan meet Cisco Unity best practices?

- A. No. The Manhattan site requires another Cisco Unity server for the second Exchange server.
- B. Yes.
- C. No. A DC/GC is required in Manhattan.
- D. No. You must add Cisco Unity and associated resources for the Boston location.

Answer: C

QUESTION 68:

Certkiller .com is replacing their voice-mail system with a Cisco Unified Messaging system. They have 1400 employees at their headquarters location, and 800 employees spread out over 80 branch locations. They have recently deployed a Cisco Unified CallManager cluster at the headquarters location that provides centralized call processing for the branch locations.

Certkiller .com has an existing phone system that will be phased out slowly, but for now they need one voice-mail system to support both the existing phone system and the Cisco Unified CallManager. The existing voice-mail system is used for both voice mail and Auto Attendant functions. The existing system has 36 ports.

Thirty-two ports are used for Auto Attendant and voice mail. The last four are used for dial-out notification. The Auto Attendant provides outside callers with a menu of options that allows their call to be routed to a department. While each subscriber greeting is played, the caller is offered the option to "press 1 to page this person now."

The old voice-mail system would then ask the caller to enter the number at which the caller can be reached and then page the subscriber with that number. The caller can press 0 and be routed to the operator for that department. When a caller chooses either the sales or the service department, the caller is sent to a queue for the next available person in that department. Managers can also modify the Auto Attendant greetings to play different prompts by dialing into the main Auto Attendant number.

What are two major concerns that need to be analyzed prior to the deployment of the Cisco Unity Unified Messaging system? (Choose two.)

- A. Auto Attendant greetings cannot be changed over the phone.
- B. model and version of the existing phone system
- C. Cisco Unity cannot queue callers for a busy extension.
- D. The paging feature described is not available with Cisco Unity.

Answer: B,D

QUESTION 69:

You are preparing a Cisco Unity design for Certkiller .com who uses Microsoft Exchange 2000 for its messaging infrastructure. Certkiller .com wants unified messaging with "spell by name" message addressing between all users at all sites. Certkiller .com wants to use the Broadcast Message feature for all sites, so that every employee will receive the "voice message of the day" on that day. They have four sites with five servers in each site to support the local users at the site. They have a fifth site that uses Exchange 5.5. The 5.5 site has a low-bandwidth connection. Additionally, the site connector has delivery setup scheduled for batch message delivery between 1:00 a.m. and 5:00 a.m. to allow for maximum bandwidth during business hours. Select the true statement.

- A. Install Cisco Unity servers at every site in the same customer Active Directory domain, and upgrade the bandwidth at the fifth site to change the site connector schedule to 24-hour delivery.
- B. Install Cisco Unity servers at every site in the same customer Active Directory domain. Upgrade the fifth site to Microsoft Exchange 2000, and upgrade the bandwidth to change the site connector schedule to 24-hour delivery.
- C. Install Cisco Unity servers at every site in a separate Active Directory domain. Upgrade the fifth site to Microsoft Exchange 2000, and upgrade the bandwidth to change the site connector schedule to 24-hour delivery.
- D. Install Cisco Unity servers at every site in a separate Active Directory domain. Upgrade the fifth site to Microsoft Exchange 2000 and change the site connector schedule to 24-hour delivery.

Answer: B

QUESTION 70:

You are developing a plan for a Cisco Unity Unified Messaging installation for Certkiller .com. Certkiller .com messaging infrastructure consists of three Exchange administrative groups. The total number of Cisco Unity users will not exceed 5000. Based on only the information provided, how many Cisco Unity servers will you propose?

- A. 3

- B. 5
- C. 1
- D. 2

Answer: A

QUESTION 71:

Exhibit:

1. 96 ports of voice messaging on one Cisco Unity Server.
2. Integration to the TDM Avaya telephone system.
3. Voice messages must be available from the telephone and from the Exchange Outlook client.
4. In the event of a system failure a backup system will take over.

You are working with a new customer to define which features they require and to compare that to which features Cisco Unity 4.2 can provide. You have defined that they require. Please refer to the exhibit,

Select the two statements below that are correct. (Choose two.)

- A. You will include failover as part of your design.
- B. You will include Cisco Unity Inbox licenses as part of your design.
- C. They will need two Cisco Unity servers because Cisco Unity supports only 96 ports on one server if the integration is with Cisco Unified CallManager.
- D. They will need two Cisco Unity servers because Cisco Unity will not support 96 ports on one server.
- E. Cisco Unity works with all Avaya telephone systems.

Answer: A,C

QUESTION 72:

Exhibit:

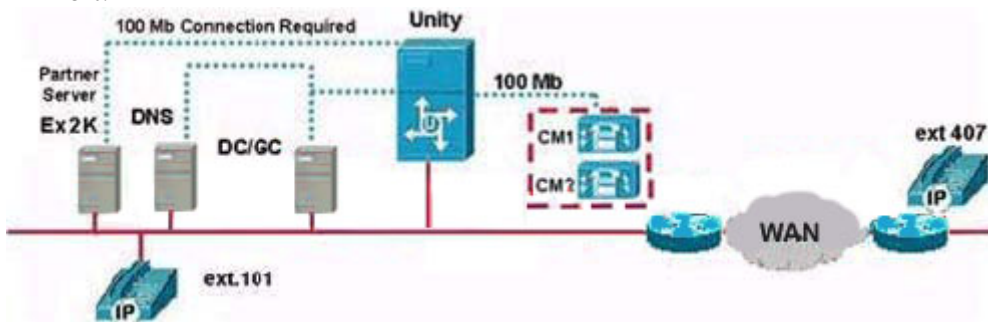

Please study the exhibit carefully. Given the information shown and knowledge that hardware transcoders are installed on the routers, which codec should be used by the Cisco Unity server for prompts and message record format?

- A. G.729a
- B. G.726

- C. GSM 6.10
- D. G.711

Answer: D

QUESTION 73:

Exhibit

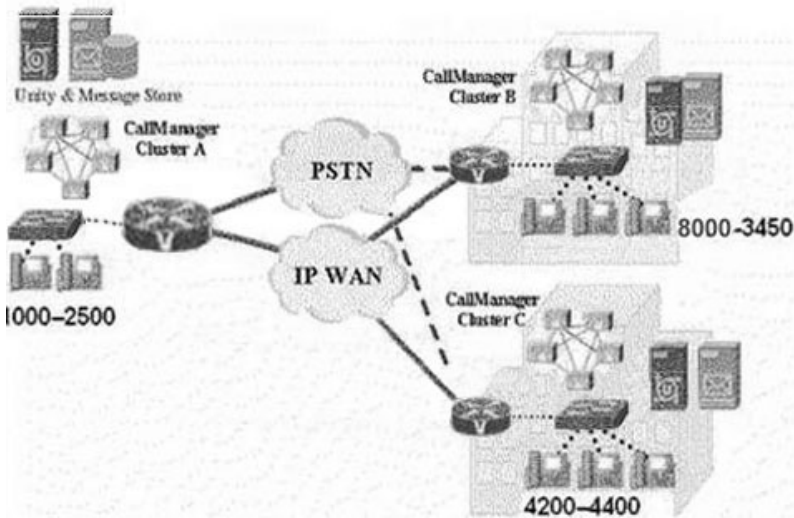

CallManager Cluster A and Unity use extension range 1000-2500. CallManager Cluster B and unity use extension range 3000-3450. CallManager Cluster C and unity extension range 4200-4400.

Your customer Certkiller .com wants to deploy Unified Messaging. Exchange stores are local at each site and part of the same organization. Digital networking is absolute requirement without using access codes, and callers need to be able to use the Cisco Unity Auto Attendant to reach any user at any site.

Which statement is true?

- A. To deploy unified Messaging, You need three separate dialing domains.
- B. Configure all Unity servers into the same dialing domain, and each Unity's call handler search scope to that dialing domain.
- C. Unity servers A and B are in the same dialing domain and the Unity C uses Extension masking to address any extension conflicts with them.
- D. No dialing domains need to be created. All unity servers need to know about each other via Active Directory. The CallManager cluster will handle any overlapping dial plan with partitions and calling search spaces.

Answer: B

QUESTION 74:

A customer has 22,000 users. Approximately 15,000 users are located at a centralized campus area and the remaining 7,000 users are distributed across

twenty separate remote locations.

All services are centralized, including telephony and messaging. Of the twenty remote locations, ten have a maximum of 50 users and a T1 WAN connection to the data center located at the centralized campus.

The customer wants Unified Messaging and wants to use text to speech. They plan to roll out View Mail for Outlook (VMO) to all users, prior to installing Unity to service the centralized Exchange servers.

How should VMO be configured for the remote users?

- A. All remote users are configured to use unity inbox.
- B. The remote VMO clients should be configured to use remote mode access.
- C. The remote VMO clients should be configured to use Telephone Record and Playback (TRaP).
- D. The remote VMO clients should be configured to only allow download before playback. Telephone Record and Playback (TRaP) should not be used for the remote clients.

Answer: D

QUESTION 75:

Exhibit

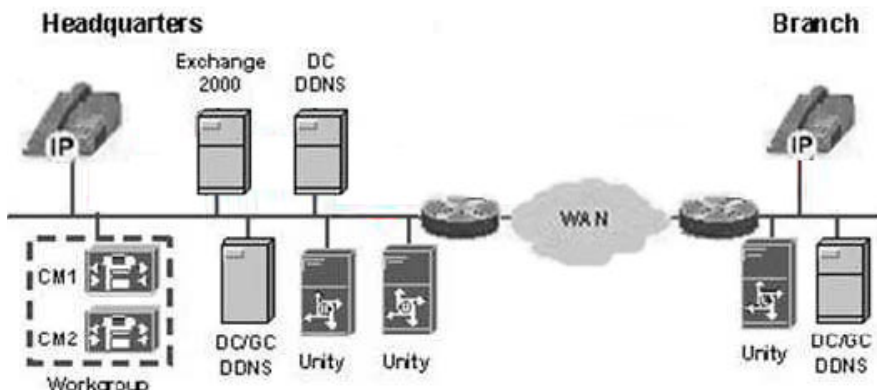

Which messaging deployment shown in the exhibit?

- A. branched messaging
- B. distributed messaging
- C. exchange clustered messaging
- D. This is not a supported message deployment model.

Answer: D

QUESTION 76:

In a purely distributed environment for both call processing and messaging, you discover that you will need to have a single Unity server collocated in each branch. As you press for more information regarding existing PBX's and their layout, the

customer the customer asks you why this PBX information is so important in a design.

What is the best answer you can give the customer?

- A. You need to understand the PBX layout so you can design the Unity solution.
- B. You do not need the PBX information as it is simply not important to this design.
- C. You need more PBX information to determine how to effectively collapse? Their call processing environment for them.
- D. You need the PBX information so you can determine which messaging system (Microsoft Exchange or Lotus Domino) would best fit into their plans.

Answer: A

QUESTION 77:

If a customer has a distributed messaging deployment model, all messaging infrastructure components must also be distributed. If Unity will service Exchange 2000, all the messaging infrastructure components that Exchange and Unity need should be collocated with them.

For Exchange 2000 and unity, what messaging infrastructure components are necessary, and which are optional?

- A. Both a domain controller and global catalog are necessary. Remote e-mail clients are not necessary. SQL servers are optional.
- B. At least one Windows 2000 domain controller, one Windows 2000 global catalog server, and one SQL server are necessary. Local clients are also required.
- C. At least one Windows 2000 domain controller, one Windows 2000 global catalog server, name resolution supported by windows 2000, and e-mail clients are required.

Answer: C

QUESTION 78:

Your customer Certkiller .com has fully distributed message store environment across WAN links that run at 256k. There are 500 subscribers in each physical site. There are five set and four of them mountain main stores.

Cisco Unity design requirements state that a minimum you must have how many Unity servers?

- A. 2
- B. 4
- C. 5
- D. 8

Answer: B

QUESTION 79:

Exhibit

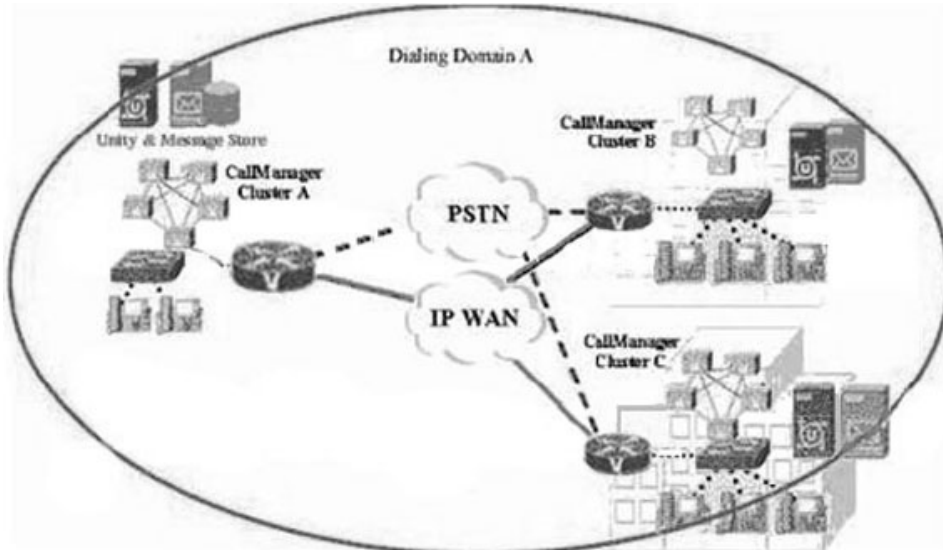

CallManager Cluster A and unity use extension range 1000-650. CallManager Cluster B and Unity use extension range 2000-450. CallManager Cluster C and Unity extension range 1500-950.

Your customer Certkiller .com wants to deploy Unified Messaging. Exchange stores are local at each site and part of the same organization. Digital networking is an absolute requirement without using access codes.

Which statement is true?

- A. All Unity servers are in different locations, but are part of the same dialing domain.
- B. A unique dialing domain is created per unity location. The other Unity locations are automatically available at that time.
- C. All Unity servers are in the same dialing domain and CallManager Cluster C to change the extensions that overlap with the CallManager Cluster A.
- D. Unity servers A and B are in the same dialing domain and Unity C put into its own dialing domain to address the extension conflicts with Unity A and B.

Answer: C

QUESTION 80:

Exhibit

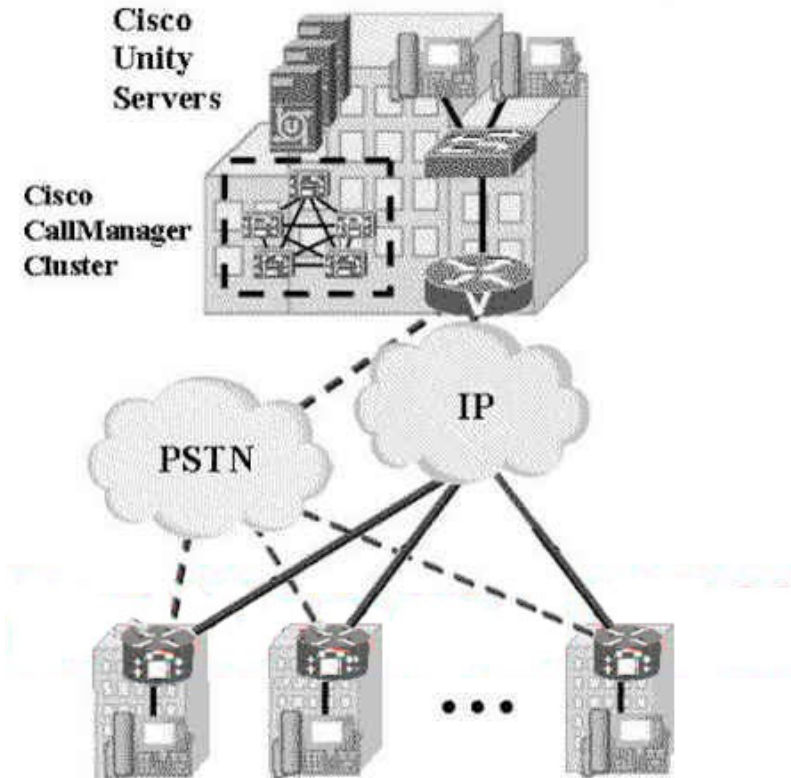

Each remote location has 15 users with a telephone and voice mailbox, with a 256K WAN link. Transcoding is available at the main location. Which codec(s) can Unity default configuration support?

- A. G.726 only
- B. G.711 only
- C. G.729a only
- D. G.711 and G.726
- E. G.711 and G.729a

Answer: E

QUESTION 81:

Your customer Certkiller .com has five Lotus Domino domains and manages five separate address books, along with five remote mail stores. They do this as result of recent acquisitions. They would like to merge these in the future and want to understand how this affects their Cisco Unity considerations today. Which statement is true?

- A. They need to consolidate address books before they can install Unity
- B. They need least three Unity servers. Each Unity can connect to two names .nfs servers simultaneously.
- C. They need at least one Unity server in this environment, as Unity can service an unlimited number of address books.

D. They need at least five Unity servers. A single Cisco Unity can only monitor one copy of names.nfs at a time, from a single Domino domain.

Answer: D

QUESTION 82:

Exhibit.

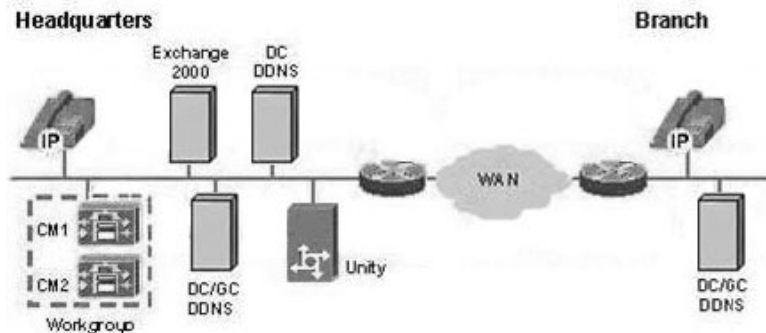

Which Cisco Unity messaging model is shown in the exhibit?

- A. branched messaging
- B. clustered messaging
- C. centralized messaging
- D. distributed messaging

Answer: C

QUESTION 83:

A customer maintains a distributed Legacy voice mail and messaging infrastructure. They also have a distributed call processing environment, consisting of Legacy PBX gear they maintain a dual data center layout in Los Angeles and Bakersfield, with two smaller remote branch offices in San Diego and El Centro. One of their goals this fiscal year is to collapse their messaging environment into a centralized topology, and gain increased return on investment by streamlining processes and administration through their two data centers. They want to move from their Legacy voice mail system to a Unified Messaging environment with Cisco Unity.

You request a meeting with the customer to discuss options for collapsing their call processing infrastructure as well. At this meeting, you find they cannot collapse their Legacy call processing environment to centralized Cisco CallManager. They must keep the Legacy PBX's Functioning for at least two more years as stipulated in their lease agreement.

Centralizing messaging is their first priority. You request all PBX type/release information from the customer and you discover that their current PBX's are fully supported by Cisco Unity. The PBX's are all from the same manufacturer, capable of networking functions and can take care of MWI's. 5-digit dialing is available

from any phone in their network.

What is your recommendation to the customer?

A. You recommend centralized Unity servers. Unity MUST reside as close as possible to the centralized mail stores it will be servicing. You can easily centralize the unity connection to the local PBX's, while servicing the remote branch office users at the same time.

B. You recommend centralized AND distributed Unity servers. You can centralize at the data centers and distribute to the edge. You MUST do this to meet the customers requirements for transparent dialing throughout the entire organization, and to comply with the 5 digit dial plan they have in place today.

C. You recommend distributed Unity servers. Unity MUST reside as close as possible to the centralized mail stores. HOWEVER in case of 5 digit dialing, you MUST physically place the Unity servers as close as possible to the remote branch users to be functional. This requirement overrides the need to be close to the mail stores, and you must consider in your design.

D. You recommend centralized Unity servers. Unity MUST reside as close as possible to the centralized mail stores it will be servicing. You can easily centralize the Unity connection to the PBX's, while servicing the remote branch office users at the same time. The only caveat you must discuss with the customer is the issue with the dual-switch? capability that Unity must leverage to simultaneously connect to CallManager and the Legacy PBX's in the remote sites.

Answer: A

QUESTION 84:

Exhibit

Which type of Cisco Unity deployment is shown in the exhibit?

- A. localized call processing, branched messaging
- B. centralized call processing, localized messaging
- C. distributed call processing, distributed messaging
- D. centralized call processing, centralized messaging

Answer: D

QUESTION 85:

Exhibit

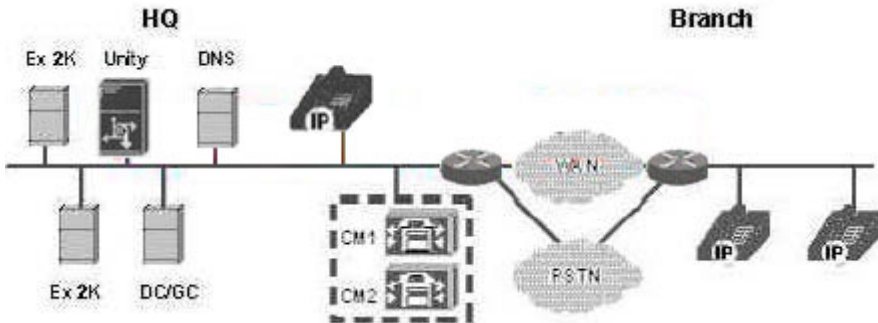

Given the information shown in the exhibit, what is the best solution for voice mail access in the event of a WAN outage?

- A. No access to voice mail can be provided until the WAN is restored.
- B. Automated alternate route (AAR) can be configured to route incoming calls that were forwarded to voice mail system.
- C. Survival Remote Site Telephony can be configured to route incoming calls that were forwarded to voice mail over PSTN back to the voice mail system.
- D. Remote users' calls are forwarded to the router where they can leave a message. When the WAN is restored, the router the router forwards the message to the voice mail server.

Answer: C

QUESTION 86:

Exhibit

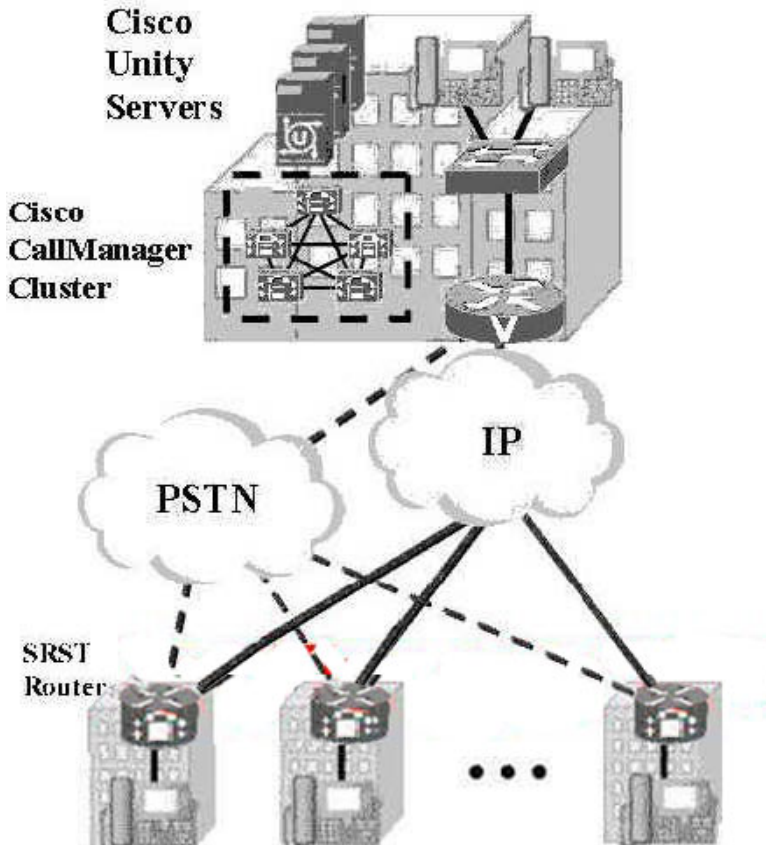

In the exhibit, Cisco Unity is integrating with a PBX using SMDI integration. Which deployment does the diagram in the exhibit represent?

- A. centralized call processing
- B. decentralized call processing
- C. localized branch call processing
- D. It is not a supported deployment.

Answer: A

QUESTION 87:

A customer has all their Exchange 2000 servers located in a centralized messaging configuration at their headquarters (HQ), which also serves as their regional data center as their regional data center. All e-mail users use Outlook, regardless of their location.

The customer has two Legacy PBX's that Unity can support located at the data center. These Legacy PBX's are used only by the users located at HQ. The remote users use CallManager. The breakdown for the number of users of each system is:

Legacy PBX 1 = 6000 phones

Legacy PBX 2 = 5000 phones

CallManager Cluster = 6000 remote IP Phones

The Exchange 2000 servers are configured into Active-Active clusters and support

18,000 mailboxes, with up to 3,000 mailboxes on each cluster. The customer will allocate extra Exchange servers to support Unity.

The breakdown is:

Exchange 2000 cluster 1 = 3,000 mailboxes

Exchange 2000 cluster 2 = 3,000 mailboxes

Exchange 2000 cluster 3 = 2,000 mailboxes

Exchange 2000 cluster 4 = 2,500 mailboxes

Exchange 2000 cluster 5 = 1,000 mailboxes

Exchange 2000 cluster 6 = 3,000 mailboxes

Exchange 2000 cluster 7 = 3,000 mailboxes

Exchange 2000 cluster 8 = 1,000 mailboxes

All Exchange 2000 clusters are installed into the same Windows 2000 site and into the same Exchange 2000 Admin group and routing group.

All users, regardless of whether they are local or remote are grouped on separate databases in different Unified Messaging except for Exchange 2000 cluster 5. The disk arrays used by this cluster were upgraded and now there is enough capacity to support Unified Messaging.

The customer wants administration of all subscribers to be easy. They also want to have a Unity server performing dual integration with Legacy PBX 2 and the CallManager cluster.

Given this scenario, how many Unity servers are needed and how should they be configured to support the eight Exchange 2000 clusters?

- A. Unity can only support five Exchange 2000 clusters so you must have at least two Unity servers. You can then connect one Unity server to one Legacy PBX and the CallManager cluster and then connect the other Unity server to the other Legacy PBX.
- B. You need four Unity servers and you need to set up a separate partner server for each Unity server. You can then connect one Unity server to two Exchange 2000 clusters. Two Unity servers can connect to Legacy PBX 1, one Unity server can connect to Legacy PBX 2 and CallManager, and one Unity server can connect to CallManager.
- C. You should have three 72-port Unity servers connected as follows: one Unity server for Legacy PBX1, one Unity server for Legacy PBX 2 and CallManager, and one Unity server for CallManager. Since the 6000 remote users are spread across all eight Exchange 2000 clusters, each Unity server should connect to all eight Exchange 2000 clusters and one partner server should be used for all three Unity servers.
- D. You should have three 72-port Unity servers connected as follows: one Unity server for Legacy PBX1, one Unity server for Legacy PBX 2 and CallManager, and one Unity server for CallManager. Since the 6000 remote users are spread across all eight Exchange 2000 clusters, only two Unity servers need to connect to all eight clusters. The third Unity server only needs to connect to the four cluster that have local users.

Answer: C

QUESTION 88:

A customer maintains a distributed Legacy voice mail and messaging

infrastructure. They also have a large distributed call processing environment consisting of Legacy PBX gear. They maintain a single data center in New York City with large remote branch offices in Atlantic City, Los Vegas, Rome, and the British Virgin Islands.

One of their goals the fiscal year is to collapse their messaging environment into a centralized topology, and gain increased return on investment by streamlining process and administration through the New York data center location. They want to move from their Legacy voice mail system to a Unified Messaging environment with Cisco Unity.

You request a meeting with the customer and discuss options for also collapsing their call control infrastructure. They tell you they simply do not have the staff or the budget to do both this fiscal year. Messaging is their first priority.

You request all PBX type/release information from the customer and you discover that their current PBX's are all supported by Cisco Unity. The PBX's are not networked together.

Given this information, what is your recommendation to the customer?

- A. You recommend centralized Unity servers, with distributed PBX support. Unity MUST reside as close as physically possible to the messaging servers it will be servicing.
- B. You recommend distributed Unity servers, with centralized messaging support turned on. Unity MUST reside as close as physically possible to the PBX's it will be servicing.
- C. You recommend centralized Unity servers ONLY for the branch offices that have a highly available LAN type connection for Unity to integrate to the PBX. All other offices will need Unity servers at their sites.
- D. You recommend distributed Unity servers for all single sites where a PBX currently resides. Since the PBX's are not networked they MUST have a Unity at each site.
- E. Since Unity cannot service remote message stores, and it cannot service remote Legacy PBX's that are not networked in some way, you need to figure out how to work within the constraints of the customer's timelines to design a feasible solution.

Answer: E

QUESTION 89:

Your company wants to create a limited directory search so that VPIM subscribers are not accessible through the directory.

When you create your directory handler, which search option should you choose?

- A. Location
- B. Dialing Domain
- C. Subscriber Template
- D. Public Distribution List

Answer: D

QUESTION 90:

Your company wants to limit directory searches by departments.
When you create your directory handlers, which search option should you choose?

- A. Location
- B. Dialing Domain
- C. Global Address List
- D. Public Distribution List

Answer: D

QUESTION 91:

Exhibit

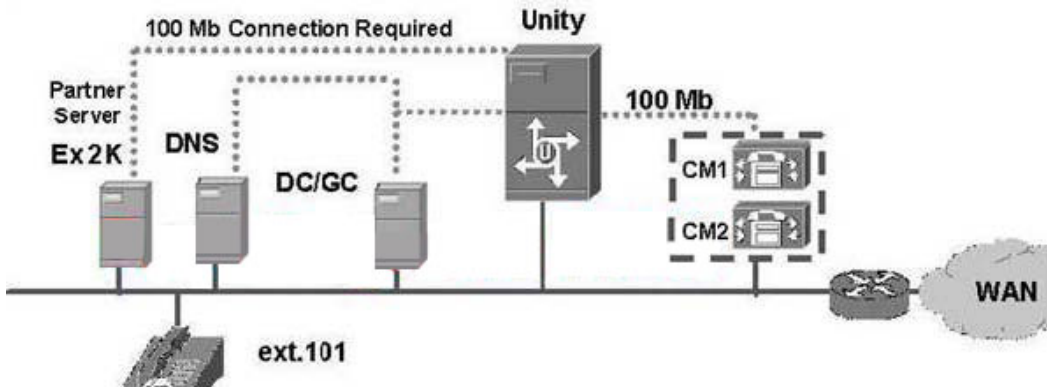

Telephones in the branch office are using the G.729a codec.
Given the information shown in the exhibit and knowledge that hardware transcoders are installed on the routers, according to best practice, which codec should be used by Cisco Unity?

- A. G.711
- B. G.726
- C. G.729a
- D. GSM 6.10

Answer: A

QUESTION 92:

Exhibit

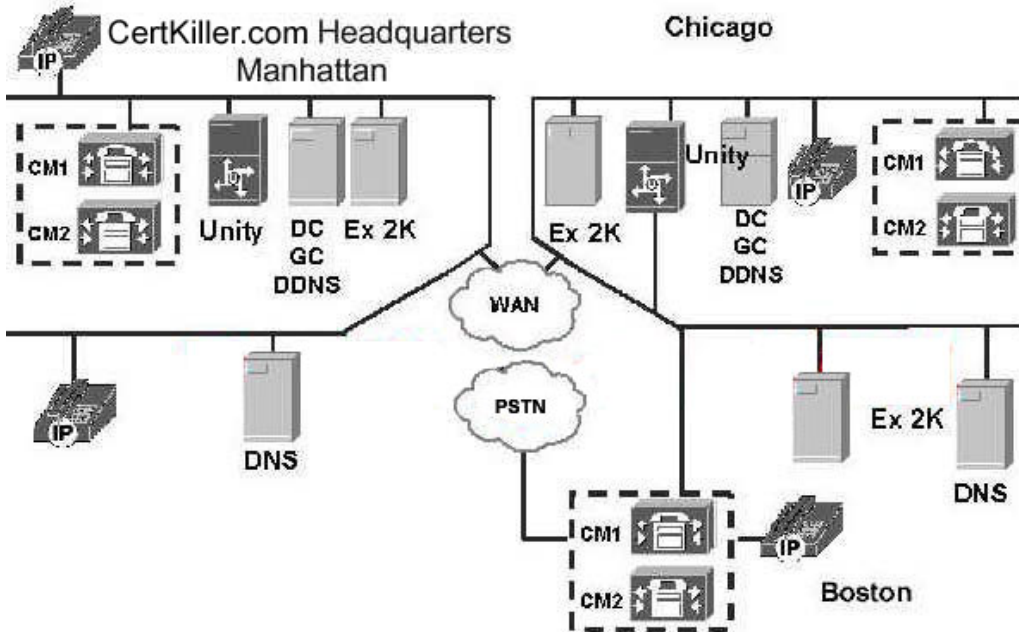

Certkiller .com will be implementing the Unity messaging solution over the coming months. The initial deployment is going to be voice mail only but will migrate to Unified Messaging within 12 months. Certkiller .com is one of the world's largest brokerage firms. This corporation was founded in 1956 and has been known for providing advanced communication services to its brokers ensuring the fastest and most reliable communication.

Since the company's inception in 1956, it has expanded from its headquarters (HQ) in Manhattan, adding offices in seven US cities and five international locations. The Manhattan HQ has the largest number of employees (3,500). The other US cities are Chicago (1,200), Miami (450), Boston (820), Dallas (350), Seattle (350), Los Angeles (1,100). The international locations are Madrid, Spain (300), London, England (200), Paris, France (300), Tokyo, Japan (450), and Kuala Lumpur, Malaysia (500). Certkiller .com uses Cisco routers, switches, firewalls, intrusion detection, and has installed Cisco CallManager clusters at every location. The corporate network uses Microsoft Windows 2000 Active Directory.

There are two forests. The root domain in the first forest is cns.com. There is a second domain in the forest called cns.internal. The second forest root is cnsasia.com. It is the only domain in the forest.

There are redundant domain controllers and global catalog servers at every location. DNS and DHCP servers are located at every location.

The HQ site has two OC-48 connections using HSRP. All sites have redundant T3's using HSRP along with a T1 to every location, providing a fully meshed architecture.

Certkiller .com uses an Exchange 2000 messaging platform. There are no planned upgrades to Exchange 2003 at this time.

There are two Exchange organizations. Org1 includes all North American and European servers and Org2 includes all Asian servers. Both organizations utilize a single routing group. Org2 has each city's Exchange servers in a unique administration group, while Org1 has a single administration group. Each office has

local Internet connectivity, and each office maintains its own Exchange servers. What should be considered when creating a proposal to ease a future migration to Unified Messaging? (Use the exhibit to help determine the correct answer. It does not show all sites.)

- A. Nothing needs to be done to the design to make migration to Unified Messaging easier.
- B. When adding subscribers to each of the Cisco Unity servers, user names should match those in use in Exchange. The names should be hidden from the global address list. Migrate Subscriber Data and ExMerge are used to move Unity-specific attributes and messages.
- C. When adding subscribers to each of the Cisco Unity servers, user names cannot match those in use in Exchange. The names should be hidden from the global address list. Migrate Subscriber Data and ExMerge are used to move Unity-specific attributes and messages.
- D. When adding subscribers to each of the Cisco Unity servers, user names should not match those in use in Exchange. The names are available from the global address list. Migrate Subscriber Data and ExMerge are used to move Unity-specific attributes and messages.

Answer: C

QUESTION 93:

An electronics retailer was founded in 2001 and has been expanding rapidly. It has 21 existing locations throughout the Mid-Atlantic States. It plans to implement the Cisco unity Messaging solution over the coming months. This Unity System will integrate with Cisco call manager v3.3.

The company uses Cisco routers, switches, and firewalls. They installed a Cisco CallManager cluster at the hosting center before the first opened. The corporate network uses Microsoft Windows 2000 servers at the central hosting center with Windows XP PC's at the stores

There is a single forest and a single domain. All domain controllers and catalog servers, and DNS servers reside at the hosting center. There are several database servers for inventory management at the hosting center.

Each store has dual T1's terminating at the hosting center via newly installed 3745 routers. The 3745 router were selected because of their scalability. The switched infrastructure at each store is a single 48-or 24 port Cisco 3550 switch.

All store locations use the single CallManager cluster, two MCS-7835 servers, located at the hosting center. Currently, most calls are to other stores or to the hosting center. Locations are configured to allow three concurrent calls over the WAN from each store.

Management is concerned about the effects of the network outages on the stores' ability to communicate with one another headquarters, and their Cisco Unity voice mail stored at the hosting center.

What recommendation would you make to ensure access to voice mail and the

PSTN during a network outage?

- A. use a redundant set of 3745 routers and BRI lines to provide service to Cisco Unity during a network outage
- B. configure a redundant set of 3550 switches and PRI lines to provide service to Cisco Unity during a network outage
- C. use the 3745 routers for SRST and PSTN connections; configure the 3745 to provide DTMF access to the Unity server via the PSTN
- D. configure the 3550 switches for SRST and PSTN connections; configure the 3550 to provide DTMF access to the Unity server via the PSTN

Answer: C

QUESTION 94:

Certkiller .com is one of the world's largest brokerage firms. This corporation was founded in 1956 and is known for providing advanced communication services to its brokers, ensuring the fastest and most reliable communication. Certkiller .com currently has over 10 million customers who trust them for the buying, selling, and trading of mutual funds, stocks, and precious metals.

The Company Headquarters (HQ) is located in Manhattan. It has offices in seven cities in the United States and five international cities. HQ has 3500 employees. Other U.S. locations include the Chicago office (1,200 employees); Miami (450 employees); Boston (820 employees); Dallas (350 employees); Seattle (350 employees); and Los Angeles (1,100 employees). International locations include Madrid, Spain (300 employees); London, England (200 employees); Paris, France (300 employees); Tokyo, Japan (450 employees); and Kuala Lumpur, Malaysia (500 employees).

The company uses Cisco routers, switches, firewalls, and intrusion detection and has installed Cisco CallManager clusters at all locations. The corporate network uses Microsoft Windows 2000 Active Directory.

There are two forests. The first forest has two root domains: coa.com. and coa.internal. The second forest root has only one domain, coaasia.com.

There are redundant domain controllers and global catalog servers at each location. DNS and DHCP servers are also found at each location. The HQ site has two OC-48 connections using HSRP. All sites have redundant T3's using HSRP to the HQ along with a T1 to every location, providing a fully meshed architecture.

The company uses an Exchange 2000 messaging platform. There are no planned upgrades to Exchange 2003 at this time.

There are two Exchange organizations: Org 1 includes all North American and European servers and Org 2 includes all Asian servers. Both organizations use a single routing group. Org 2 has each city's Exchange servers in a unique administration group, while Org 1 has a single administration group. Each office has local Internet connectivity, and each office maintains its own Exchange servers. Certkiller .com just upgraded to Cisco CallManager at all locations. Two MCS-7835 servers are located at each site, except HQ, which has three MCS-7835 servers.

There are inter-cluster trunks established between all subscribers in all clusters. Certkiller .com likes the ability to route all intra-company calls over their 3DES encrypted network links. The existing voice messaging platform was provided by several different vendors and there is no networking between them. Certkiller .com plans to change voice messaging platforms at all locations to Cisco Unity. The system will initially be voice mail only. but will switch to Unified Messaging during the next fiscal year. Unity servers will be placed in each office. Which kind of networking should you implement to provide messaging among all the offices?

- A. Only digital networking must be implemented on all servers.
- B. Only VPIM networking must be implemented on all of the servers.
- C. Digital networking must be implemented on all servers. VPIM networking must be implemented between the North American/European and Asian forests.
- D. Only digital networking must be implemented on all servers and Bridge networking must be implemented between the North American/European and Asian forests.

Answer: C

QUESTION 95:

Certkiller .com is a company that sells wireless communications services to customers throughout the eastern United States. In 1999, Certkiller .com acquired a smaller wireless communications company, Company B. Company B provides similar services to Certkiller .com in the New England area.

Certkiller .com has its headquarters in Dulles, VA (3253 employees) and its branch offices are located in Richmond (1131 employees), Baltimore (748 employees), Washington DC (442 employees), Philadelphia (115 employees), and Trenton (26 employees). Company B has its headquarters in New York (414 employees), and its branches are in Boston (212 employees) and Providence (89 employees).

Certkiller .com will be implementing a centralized Cisco Unity deployment. When customers call an employee, the company wants to provide quick service on those directory lookups.

Which implementation does the best job of delivering the service?

- A. buy a Platform Overlay 5 server with extra memory and processor speed to provide the quickest service
- B. build a directory handler for each office: put each subscriber in a distribution list for that office; make that list limit the directory handler search; build an introductory call handler from the opening greeting that provides one key dialing to each of the offices
- C. build multiple directory handlers that break the company population into groups arranged alphabetically by last name; make four groups as equal as possible in size; build an introductory call handler from the opening greeting that provides one key dialing to each of the four groups
- D. build two directory handlers: one for Company A, and one for Company B; add subscribers to the appropriate subscriber template and use that template to limit the

directory search; build an introductory call handler from the opening greeting that provides one key dialing to each of the directory handlers

Answer: B

QUESTION 96:

Certkiller .com is one of the world's largest brokerage firms. This corporation was founded in 1956 and is known for providing advanced communication services to its brokers, ensuring the fastest and most reliable communication. The company currently has over 10 million customers who trust them for the buying, selling and trading of mutual funds, stocks, and precious metals.

Certkiller .com Headquarters (HQ) is located in Manhattan. It has offices in seven cities in the United States and five international cities. HQ has 3500 employees. Other U.S. locations include the Chicago office (1,200 employees); Miami (450 employees); Boston (820 employees); Dallas (350 employees); Seattle (350 employees); and Los Angeles (1,100 employees). International locations include Madrid, Spain (300 employees); London, England (200 employees); Paris, France (300 employees); Tokyo, Japan (450 employees); and Kuala Lumpur, Malaysia (500 employees).

Certkiller .com uses Cisco routers, switches, firewalls, and intrusion detection and has installed Cisco CallManager clusters at all locations. The corporate network uses Microsoft Windows 2000 Active Directory.

There are two forests. The first forest has two root domains: coa.com and coa.internal. The second forest root has only one domain, coaasia.com.

There are redundant domain controllers and global catalog servers at each location. DNS and DHCP servers are also found at each location. The HQ site has two OC-48 connections using HSRP. All sites have redundant T3's using HSRP to the HQ along with a T1 to every location, providing a fully meshed architecture.

Certkiller .com uses an Exchange 2000 messaging platform. There are no planned upgrades to Exchange 2003 at this time.

There are two Exchange organizations: Org 1 includes all North American and European servers and Org2 includes all Asian servers. Both organizations use a single routing group. Org2 has each city's Exchange servers in a unique administration group, while Org1 has a single administration group. Each office has local Internet connectivity, and each office maintains its own Exchange servers.

Certkiller .com just upgraded to Cisco CallManager at all locations. Two MCS-7835 servers are located at each site, except for the HQ site, which has three MCS-7835 servers. There are inter-cluster trunks established between all subscribers in all clusters.

Certkiller .com likes to route all intra-company calls over their 3DES encrypted network links. The existing voice messaging platform was provided by several different vendors and there is no networking between them.

Certkiller .com plans to change voice messaging platforms at all locations to Cisco Unity. The system will initially be voice mail only, but will switch to Unified Messaging during the next fiscal year.

Where should Cisco Unity servers be located to provide the best messaging and addressing service?

- A. All servers should be located at corporate HQ.
- B. A server should be located in all offices with Exchange servers.
- C. All servers for North America should be located at corporate HQ and servers should be located in each office in the international locations.
- D. Servers should be located in all North American offices, in London to serve the three European offices, and in Tokyo to serve the two Asian offices.

Answer: B

QUESTION 97:

Certkiller .com plan to implement the Cisco Unity messaging solution over the coming months. The Unity system will be installed at the main office and will integrate with Cisco CallManager v3.3. It must work with the existing VPIM compatible voice mail system at the three branch locations until they are converted to Unity, one at a time. Unity will be using a centralized messaging deployment model.

There are 75 employees at each branch location. The IT department expects the process to take three months. They want all subscribers and outside callers to be able to address messages to all employees as soon as Unity is implemented.

Which is the best way to accomplish this goal?

- A. All main office employees are created as Unity subscribers and all branch office employees are created as VPIM subscribers. Branch employee (VPIM subscriber) accounts are rebuilt, making them Unity subscribers at one time.
- B. All main office employees are created as VPIM subscribers. When the time comes, branch employee accounts are converted using the Bulk Subscriber Import tool.
- C. Main office employees are created as Unity subscribers and all branch office employee accounts.
- D. All employees are created as Unity subscribers, calls are automatically transferred and voice messages are automatically forwarded to subscribers at the branch locations. No conversions is necessary when the branch locations are bought online.

Answer: A

QUESTION 98:

Exhibit

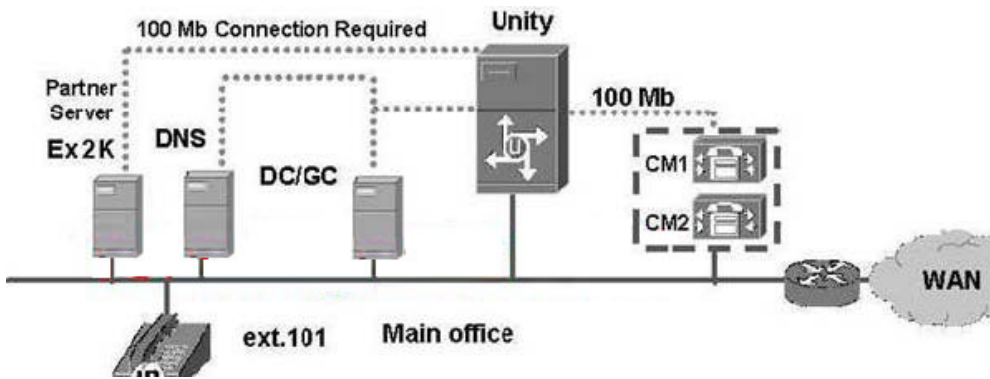

The routers shown in the exhibit do not have hardware transcoders installed between the main office and the branch office. Telephones in the branch office are in a CallManager G.729a region. Your design goal is to make the most efficient use of the single Cisco Unity server installed in the main office.

Which codec should be used by Cisco Unity for prompts and message record format?

- A. G.711
- B. G.726
- C. G.729a
- D. GSM 6.10

Answer: C

QUESTION 99:

An advertising agency with offices in New York, Chicago, Atlanta, and Los Angeles wants to modernize its communications infrastructure. Each of the offices has operated independently in the past. Recently, the company obtained more national and multi-national clients, so the need to communicate closely between offices has gained strategic significance to the company.

Each office currently maintains its own PBX, e-mail, and voice mail systems. The company has determined that it will implement a Cisco CallManager/Cisco Unity solution as a replacement for the disparate systems in a phased approach.

Management is meeting resistance from the Los Angeles office, which purchased a new NEC NEAX 2400 just 6 months ago. Their voice mail can be replaced but it will be several years until the PBX is fully depreciated.

The IT department is building a data center in Chicago and there will maintain a CallManager cluster providing service to New York, Atlanta, and Chicago. There is a single forest and a single domain. All domain controllers, global catalog servers, and DNS servers reside at the data center. Cisco Unity servers will be installed locally at each office.

Each office has dual T3's terminating back at the data center via newly installed 3745 routers. The 3745 were selected because of their scalability. The switched infrastructure at each office consists of a 48-port Cisco 3550 switches. Each office currently has a four-digit plan in the 1000-9999 range.

Which practice design should you implement?

- A. leave the Chicago extensions in the 1000?999 range; renumber New York in the 2000?999 range, Atlanta in the 3000?999 range, and Los Angeles in the 4000?999 range.
- B. leave all extensions in 1000?999 range; put each of the Unity servers in their own dialing domain; use alternate extensions on all the Unity servers to simplify message addressing.
- C. leave all extensions in the 1000?999 range; give each of the Unity servers a unique location ID; enable the Play Location to Subscriber as Part of Search Results?setting: train user to enter a location number when dialing outside their own office
- D. leave the Chicago and Los Angeles extension in the 1000?999 range; renumber New York and Atlanta in the 2000?999 and 3000?999 ranges; put the Unity servers in Chicago, New York and Atlanta in the same dialing domain; use alternate extensions on all the Unity servers to simplify message addressing

Answer: B

QUESTION 100:

Exhibit

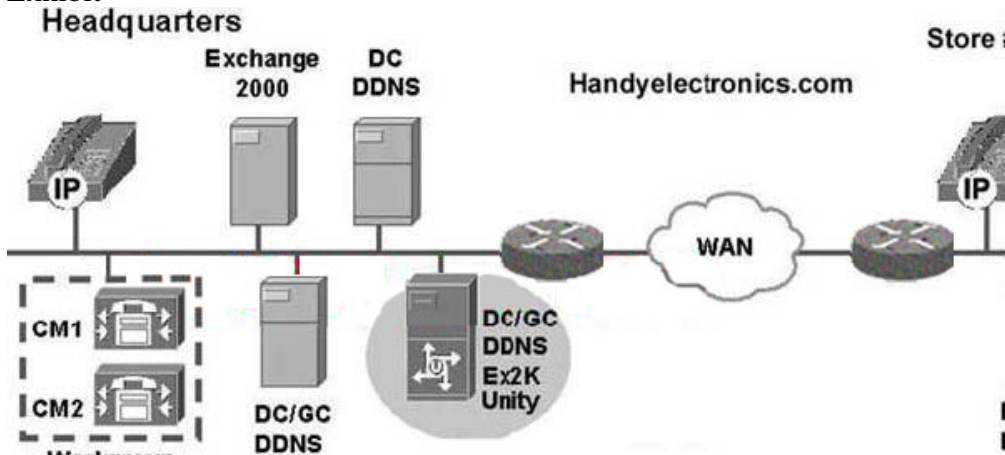

Certkiller .com is a fast-growing electronics retailer. This corporation founded in 2001 and has been expanding rapidly. It has 21 existing locations. Certkiller .com plans to implement the Unity messaging solution over the coming months.

The Unity system will integrate with Cisco CallManager v3.3. The company will start with a voice mail only installation and move to Unified Messaging in the next fiscal year. They installed a Cisco CallManager cluster at the hosting center before the first store opened.

The corporate network uses Microsoft Windows 2000 servers at the central hosting center with Windows XP PC's at the stores. There is a single forest and a single domain. All domain controllers, global catalog servers, and DNS servers reside at the hosting center. There are several data base servers for inventory management at the hosting center.

Each store has dual T1's terminating at the hosting center via newly installed 3745 routers. The 3745 routers were selected because of their scalability. The switched

infrastructure at each store is a single 48- or 24-port Cisco 3550 switch.

All store locations use the single CallManager cluster and two MCS-7835 servers, each located at the hosting center. Currently, most calls are to other stores or to the hosting center. Locations are configured to allow three concurrent calls over the WAN from each store.

The exhibit shows a simplified design proposal. Though only one store is shown, all other stores will use this design. The proposal is to place Cisco Unity in its own forest with its own directory. When it comes time to migrate to Unified Messaging, the Disaster Recovery Tool (DiRT) tool will be used. When adding subscribers to each of the Cisco Unity servers, each Exchange alias will match those currently in use in Exchange.

What should be added or changed in the proposal to facilitate a successful future migration to Unified Messaging?

- A. Nothing more needs to be done. The DiRT backup and restore process will locate the target mailbox using the matching alias.
- B. Any Exchange alias can be used. The Unity Migrate Subscriber Data Tool and Microsoft's ExMerge are used to move Unity-specific attributes and messages after a DiRT backup and restore.
- C. The names should be hidden from the global address book. The Unity Migrate Subscriber Data tool and Microsoft's ExMerge are used to move Unity-specific attributes and messages instead of a DiRT backup and restore.
- D. When adding subscribers to each of the Cisco Unity servers, Exchange aliases must not match those in use in Exchange. The names should be hidden from the global address book. The Unity Migrate Subscriber Data tool and Microsoft's ExMerge are used to move Unity-specific attributes and messages after a DiRT backup and restore.

Answer: A

QUESTION 101:

Certkiller .com is an aftermarket automotive parts supplier that maintains its corporate headquarters in Torrance, California and manufacturing plants in Bakersfield, California, Tulsa, Oklahoma; and Atlanta, Georgia. All network and phone services are provided from a hosting center located at corporate headquarters.

In 2002 they installed a Cisco CallManager cluster in the hosting center and Cisco Unity to provide voice mail for all employees. Headquarters employees' phone extensions are in the 1000-?000 range; Bakersfield employees are in the 3000 range; Tulsa employees are in the 4000 range; and Atlanta employees occupy the 5000-6000 range. Cisco Unity and Exchange servers are located at each facility. Certkiller .com uses Cisco routers, switches, and firewalls. The corporate network uses Microsoft Windows 2000 servers at the central hosting center with Windows XP PC's at the plants. There is a single forest and a single domain. All domain controllers, global catalog servers, and DNS servers reside at the hosting center. There are several database servers for inventory management at the hosting center.

Each plant has dual T3's terminating back at the hosting center via newly installed 3745 routers. The 3745 routers were selected because of their scalability. The switched infrastructure at each store is a single 48- or 24-port Cisco 3550 switch. Recently, Certkiller .com acquired Company B, another automotive parts supplier. One of their first moves was to install Cisco Unity to replace the 6 year old voice mail server with which Company B's management and employees had become increasingly frustrated. The NEC NEAX 2400 PBX providing phone service at Company B has extensions in the 1000-?000 range.

What is the most effective way to fix the overlapping dial plan so that all of the newly combined company's employees can voice message each other?

- A. reprogram the NEAX 2400 to provide extensions in the 7000?000 range
- B. put the headquarters and Bakersfield Unity servers into a dialing domain to segment the dialing plan
- C. put the headquarters Bakersfield, Tulsa, and Atlanta servers into a dialing domain to segment the dial plan and guard against future overlap
- D. replace all of the telephones and network wiring at K & M so they can use the Cisco CallManager at the hosting center with extensions in the 7000?000 range

Answer: C

QUESTION 102:

A customer is seeking proposals to replace their voice mail system with a Unified Messaging system, which is to be coordinated with their Exchange 2000 rollout. They have 2,000 employees at their headquarters location, 800 employees at their data center, and 1,000 employees at their 80 branch locations.

Headquarters has redundant OC-3 connections to the data center and is using a Nortel PBX. They have recently deployed a Cisco CallManager cluster at the data center, which provides centralized call processing for the branch locations.

The Unified Messaging system must provide call answering and MWI for the IP Phones and the existing Nortel PBX. The customer has a corporate policy that all server resources must be located at the data center when possible.

Your preliminary design calls for a Unity server at the data center that will integrate with the existing Exchange 2002 servers to provide Unified Messaging for all employees.

Which two should be included in your preliminary design to make this a Cisco supported design). (Choose two.)

- A. Unity server at headquarters
- B. Active Directory forest dedicated for Unity
- C. Partner Exchange server at headquarters
- D. Active Directory server dedicated for Unity

Answer: A, C

QUESTION 103:

A customer is replacing their voice mail system with a Cisco Unified Messaging system. They have 1,400 employees at their headquarters location, and 800 employees spread out over 80 branch locations.

They have recently deployed a Cisco CallManager cluster at the headquarters location that provides centralized call processing for the branch locations. The customer has an existing phone system that will be phased out slowly, but for now they need one voice mail system to support both the existing phone system and the Cisco Call Manager.

The customer's existing voice mail system will be used for both Voice mail and Auto Attendant functions. The existing system has 36 ports. Thirty-two ports are used for Auto Attendant Voice Mail. The last four are used for out dial notification.

The Auto Attendant provides outside callers with a menu of options that allows their call to be routed to a department.

While each subscriber's greeting is played, the caller is offered the option of press 1 to page this person now? The old voice mail system would then ask the caller to enter the number at which the caller can be reached and then page the subscriber with that number.

The caller can press 0 and be routed to the operator for that department. When a caller chooses either the sales for the service department, the caller is sent to a queue for the next available person in that department. Managers can also modify the Auto Attendant greetings to play different prompts by dialing into the main Auto Attendant number.

What are two major concerns that need to be analyzed prior to the deployment of the Unity Unified Messaging system? (Choose two.)

- A. model and version of the existing phone system
- B. Unity cannot queue callers for a busy extension.
- C. Auto Attendant greetings cannot be changed over the phone.
- D. The paging feature described above is not available with Cisco Unity.

Answer: A, D

QUESTION 104:

You are setting up VLANs for integration with IP Telephony. Cisco Unity must reside on which VLAN for enhanced security?

- A. Null VLAN
- B. Data VLAN
- C. SMDI VLAN
- D. Voice VLAN

Answer: B

QUESTION 105:

Which is a feature of Domino Unified Communications (DUC) Services?

- A. Call Control
- B. Directory Replication
- C. Message Forwarding
- D. Message Waiting Indicators

Answer: D

QUESTION 106:

You have installed Microsoft Exchange 2000 on the Cisco Unity server. According to best practice, this indicates Cisco Unity will be used in which type of configuration (s)?

- A. voice mail only
- B. Unified Messaging only
- C. voice mail only or Unified Messaging
- D. Unified Messaging if Active Directory schema extension is run

Answer: A

QUESTION 107:

By default, Cisco Unity interacts with which directory file in Lotus Domino?

- A. Names.nsf
- B. Directory.dir
- C. Domain.nam
- D. AdSchema.dat

Answer: A

QUESTION 108:

You are attempting to manage subscribers on other Cisco Unity servers. When you attempt to connect, you are denied access. What is the most probable cause for this?

- A. You can only use Terminal Services for this function.
- B. You do not have permissions and must run the Grant Unity Access Utility.
- C. You cannot manage Cisco Unity servers located outside your dialing domain.
- D. The Cisco Unity server you are attempting to reach has the Cisco Unity Security Agent installed.
- E. Agent installed.

Answer: B

QUESTION 109:

A Disaster Recovery Tool (DiRT) backup can be restored to a _____

- A. functioning Cisco Unity of the same software level
- B. functioning Cisco Unity with an upgraded software level
- C. Cisco Unity platform with only the operating system installed
- D. Cisco Unity platform with the operating system and SQL installed

Answer: A

QUESTION 110:

You are installing Cisco Unity with failover.
Which database software do you install?

- A. MSDE
- B. SQL 7
- C. SQL 2000
- D. depends on the number of ports

Answer: C

QUESTION 111:

You have heard that Cisco Unity can react slowly to commands and the playing of messages after an antivirus tool is installed on the Unity server.
To prevent this from occurring, you _____

- A. confirm the antivirus tool is Microsoft Exchange aware
- B. do NOT run a complete file V0 scan on the Unity server
- C. do nothing as Cisco Unity will acclimate to the antivirus tool
- D. confirm it is a McAfee antivirus tool, the only antivirus tools that are supported

Answer: B

QUESTION 112:

You are installing Cisco Unity in an Exchange 5.5/2000 mixed-mode messaging configuration.
Which Exchange server(s) acts as the Cisco Unity partner server?

- A. Exchange 5.5 server only

- B. Exchange 2000 server only
- C. Cisco Unity uses the Microsoft ADC.
- D. an Exchange 5.5 or Exchange 2000 server

Answer: B

QUESTION 113:

Your customer Certkiller .com asks you to design a voice mail only Unity solution for their company of 8,000 people. They have four geographical locations and want all the users to be in one directory listing. They want outside callers to be able to locate all users from either location A or B by spelling the name of the user. They are using a UNIX-based e-mail platform.

The four locations are referred to as sites A, B, C, and D. Site A is the company's corporate headquarters and is home to 5,000 users. Site B has 2900 users and sites C and D both have 20 users.

They have a 5 digit dialing plan that connects sites A and B, but sites C and D are on separate phone and VPIM compliant voice mail systems. There is a minimum of T1 level bandwidth between sites A and B. Sites C and D are connected through PSTN with Internet Access through local gateways at the sites.

Which four actions need to be taken to meet the customer's directory requirements? (Choose four.)

- A. configure VPIM on Unity
- B. install one Unity server in each site
- C. configure one Unity with the UNIX link software
- D. configure VPIM subscribers on a Unity at Site A
- E. configure VPIM subscribers on a Unity at Site D
- F. create one dialing domain and add all Unity servers to it
- G. set the search scope on each Unity to search the dialing domain
- H. create four dialing domains and add one Unity to each dialing domain

Answer: A, D, E, F

QUESTION 114:

Your customer Certkiller .com asks you to design a voice mail only Unity solution for their company of 10,000 people. They want all 10,000 users to be in one directory listing.

Certkiller .com have four geographical locations and two Active Directory forests. The four locations are referred to as sites A, B, C and D. The two forests are known as A&B.com and D&C.com.

Which solution meets the customer's requirements?

- A. remove one of the forests; add all the servers from the removed forest to the remaining one; deploy Cisco Unity digital networking

- B. deploy Cisco Unity digital networking; set the SQL database on each Unity server to replication mode; set the search scopes of each Unity server to the replicated SQL directory
- C. set up forest directory replication connectors between A&B.com and C&D.com; deploy Cisco Unity digital networking; set the search scopes of each Unity server at the combined global address list
- D. deploy Cisco Unity digital networking in both forests; use Active Directory Management Information Synchronization (AMIS) to combine the two forests directories; set the search scopes of each Unity server to the new combined global address list.

Answer: A

QUESTION 115:

Your customer Certkiller .com has 1200 users. The users are spread evenly across three routing groups in one Exchange 2000 organization. Each routing group is in a different geographical location within a single phone system.

Certkiller .com wants you to configure a voice mail only solution with a plan to migrate to Unified Messaging. They must have the ability to send an all employee message to one distribution list and have the Automated Attendant search for all users by name, regardless of the location.

Which configuration best meets the customer's requirements?

- A. a new forest/domain with one Unity system in each new Exchange routing group
- B. a new forest/domain with three Unity systems in each new Exchange routing group
- C. a new forest/domain with one Unity system in the existing root Exchange routing groups
- D. There is no Unity solution that fits this Exchange 2000 configuration.

Answer: A

QUESTION 116:

Your customer Certkiller .com asks you to plan a voice mail only solution that works with their current network topology. They have 14,000 users on a UNIX-based e-mail platform.

All data servers, including the new Exchange mail stores you will be installing, are behind the company firewall. They want to place the Unity servers in the phone room with the TDM telephone system where there is no network access behind the firewall.

Which solution best meets the customer's requirements?

- A. do as requested, separate the mail store servers from the Unity servers
- B. have them supply access behind the firewall to the phone room for all the Unity servers

- C. place the voice mail system on a separate VLAN with the TDM communications equipment
- D. have them supply behind the firewall connections to the phone room for one of the Unity servers and set that Unity server up as the firewall bridgehead for the rest of the Unity servers

Answer: B

QUESTION 117:

Your customer Certkiller .com has 2,000 users in a single Exchange 2000 routing group. Certkiller .com requests that you configure a voice mail only solution. They plan to migrate to Unified Messaging very soon, so they want to use the existing Exchange servers.

Following the supported configurations in the Cisco Unity Design guide, what is the minimum number of Unity servers you must deploy?

- A. 1
- B. 2
- C. 3
- D. 5

Answer: A

QUESTION 118:

Your customer Certkiller .com has 5,000 users in a single Exchange 2000 routing group. Certkiller .com requests that you configure a voice mail only solution. Without planning for the domain controllers and global catalog servers, what is the minimum number of Exchange servers that you need just to locate the users?

- A. 1
- B. 2
- C. 3
- D. 4

Answer: B

QUESTION 119:

Your customer Certkiller .com asks you to consult on a plan for their Cisco Unity voice mail only solution for 9,000 users at three sites. Each site has 3,000 users. All three sites are in the same physical location.

Certkiller .com has configured the "sites" for organization and security. Sites A and B are both protected by a firewall and site C has no firewall protection. The customer wants the Unity servers installed in each of the sites, but wants the

Exchange message stores behind the firewalls.
Which statement is true?

- A. You should have the customer create a firewall for site C and add the Unity server, global catalog server, and the mail store behind the firewall for that site.
- B. This will work as long as the firewall is "Exchange aware". The firewall will protect the mail stores and still allow access to the Unity system.
- C. This will work as long as the Unity system accounts have the correct rights and permissions configured, as defined in the Firewall for Unity White Paper.
- D. For security, you should place all Unity servers and message store servers behind the firewall set up for sites A and B. For authentication you should make sure the global catalog for site C is not behind the firewall.

Answer: A

QUESTION 120:

You are asked to consult on a problem at a large voice mail only remote site. The problem is slow access for users when they log on to Cisco Unity to retrieve their messages.

There are four servers at the remote site and 4000 users in a voice mail only application. The servers are all member servers, two 48-port Unity servers and two Exchange servers 2000 users each.

The call traffic at the site is relatively low. There is never a time when all ports are busy on either Unity server. There are no problems at the headquarters site, which has the same server configuration with the addition of a domain controller and a global catalog server.

What should you recommend?

- A. The Exchange optimizer application should be run on both message stores.
- B. This is an IP windowing issue. The size of the TCPIP window needs to be increased.
- C. A global catalog server with name resolution should be added to the remote site for authentication.
- D. More fiber optic level bandwidth should be added between the Unity servers and the Exchange servers.

Answer: C

QUESTION 121:

Your customer Certkiller .com requests that you configure a large voice mail only application with the ability to handle 80 calls simultaneously. These capabilities must always be available. You must determine the number of servers necessary to provide the call handling capacity.

Which configuration best meets the customer's requirements?

- A. one 80-port Unity server and one 80-port fallover server
- B. two servers: one 40-port fallover server and one primary 40-port Unity server
- C. three servers: two 40-port Unity primary servers and one server to act as the fallover server for both primary servers.
- D. four servers: two 40-port Unity primary servers and two 40-port fallover Unity servers.

Answer: D

QUESTION 122:

Your customer Certkiller .com asks you to plan a large Unified Messaging Cisco Unity solution for their 22,000 users. They are currently upgrading all of the sites into one forest with Exchange 2003 as the standard for all e-mail servers. They will complete the upgrade in three years, so they want a temporary voice mail only solution with a clean migration path.

Following best practices, how can you accomplish this?

- A. create a separate forest/domain with new servers provisioned for the 22,000 users and use the same Exchange alias naming convention
- B. create a separate forest/domain with new servers provisioned for the 22,000 users and use a separate Exchange alias naming convention so there are no overlapping GUID issues
- C. join the forest/domain; add new servers provisioned for the 22,000 users; use the same Exchange alias naming convention so users can be changed as they are upgraded
- D. join the forest/domain: add new Unity servers provisioned for the 22,000 users; use the existing mail store and user alias; control which users get Unified Messaging via the COS of the users as they are upgraded

Answer: A

QUESTION 123:

Your customer Certkiller .com requires you to plan a voice mail only solution for 6,000 users. All users are at one physical location and they all use one phone system. Due to the volume of calls this customers receives, you propose two Cisco Unity 72-port systems, each configured to service half of the users. When a message is left for a specific distribution list, the customer requires that 50 people be simultaneously notified via touch tone paper or cell phone call. The normal call volume generally keeps half of the ports on both systems busy. Without accounting for MWIs, which solution best meets the customer's requirements?

- A. configure 25 ports on both systems for out call notification and locate half of the users on each system
- B. configure 50 ports on one system for out call notification and locate the users in that

distribution list on that server

C. configure 50 ports on one system for out call notification and locate the users in that distribution list on the other server

D. This requirement cannot be met. Members in distribution lists must be located on the same Cisco Unity server to function properly.

Answer: A

QUESTION 124:

A sales person creates an estimated Bill of Materials for a customer bid and wants you to verify the accuracy of the estimate. The customer requirements are voice mail only for 7000 people, with the capability to expand to 8500 people.

The sales person proposes the following configuration: two 72-port Cisco Unity systems configured as member servers; three new Exchange message store servers configured as member servers in a new domain; one server configured as the domain controller and the global catalog controller of the new domain.

Which statement is true about this configuration?

A. This configuration will work.

B. This configuration will not work, you need to add one more domain controller for 8,000 users.

C. This configuration will not work, you need to add two more Exchange servers for 8,000 users.

D. The number of servers is correct, but the roles of the Exchange servers must be domain controllers, not member servers.

Answer: A

QUESTION 125:

Your customer Certkiller .com asks you to design a Unified Messaging solution for 20,000 users. They need voice mail now, but will not have the Exchange server infrastructure in place for at least 10 months.

Certkiller .com has Active Directory and global catalog infrastructure set up. They want you to add your own Exchange servers in a new Active Directory forest.

However, they want to use the directory controllers global catalog servers from their current deployment.

How can you accomplish this?

A. This cannot be done.

B. use Microsoft Forest Manager to allow the current DCGC to service the new forest Exchange servers

C. install the new forest in mixed mode; place one NT PDC in both forests; set up a trust relationship between the two PDC servers to allow for user management

D. configure the servers the way the customer has requested; use Microsoft Server

Merger to temporarily place the Exchange servers from the new forest under the control of the current forest

Answer: A

QUESTION 126:

Which three require a voice connector? (Choose three.)

- A. Unity AMIS networking
- B. Unity digital networking
- C. Unity VPIM networking
- D. Unity bridge networking

Answer: A, C, D

QUESTION 127:

Exhibit

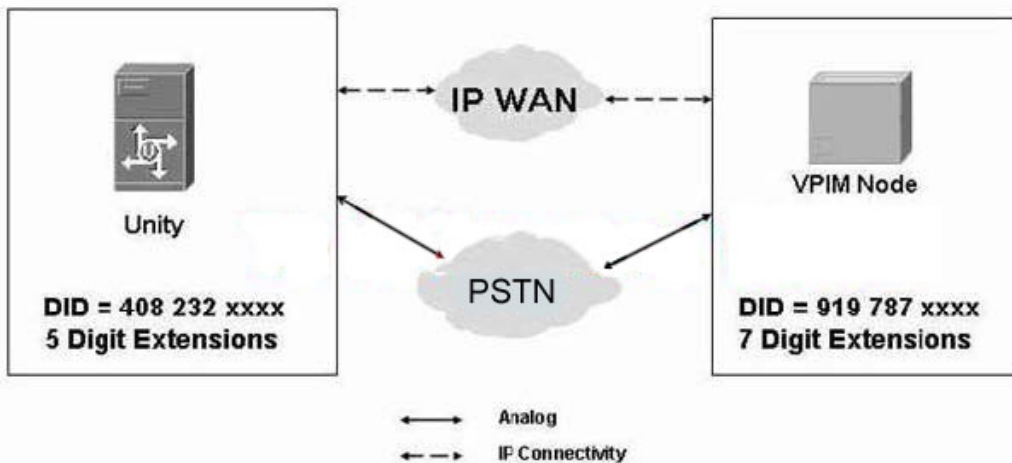

Certkiller .com needs to exchange voice messages with a supplier using VPIM. You are asked to provide dial by name and you want to maintain your internal 5 digit dialing plan. You add VPIM subscribers using a 5 digit extension and a 5 digit remote mailbox number.

Because your supplier's voice mail system only supports blind addressing, they want to use the full DID number to send messages to you.

Referring to the exhibit, which should be configured in your Unity server's VPIM delivery location?

- A. Unity Prefix = 23
- B. Unity Prefix = 40823
- C. Remote Prefix = 78
- D. Remote Prefix = 91978

Answer: D

QUESTION 128:

When addressing a message to an AMIS subscriber, information is accessed from which two Active Directory schema classes? (Choose two.)

- A. User
- B. Contact
- C. Delivery Location
- D. Primary Location

Answer: B, C

QUESTION 129:

What is required to support VPIM networking when Unity is integrated with Cisco CallManager?

- A. SMDI link to remote voice mail system
- B. IP connectivity to remote voice mail system
- C. a voice gateway that supports fourth-column DTMF
- D. ISDN PRI connectivity to PSTN or remote voice mail system

Answer: B

QUESTION 130:

Which two require specific Active Directory schema extensions? (Choose two.)

- A. Unity AMIS networking
- B. Unity VPIM networking
- C. Unity SMTP networking
- D. Unity bridge networking

Answer: B, D

QUESTION 131:

The voice connector performs which task on incoming VPIM messages?

- A. sets the address type to VOICE
- B. converts the messages to MAPI format
- C. routes messages to the UOmni mailbox
- D. converts voice attachments to the G.729a audio format

Answer: B

QUESTION 132:

Exhibit

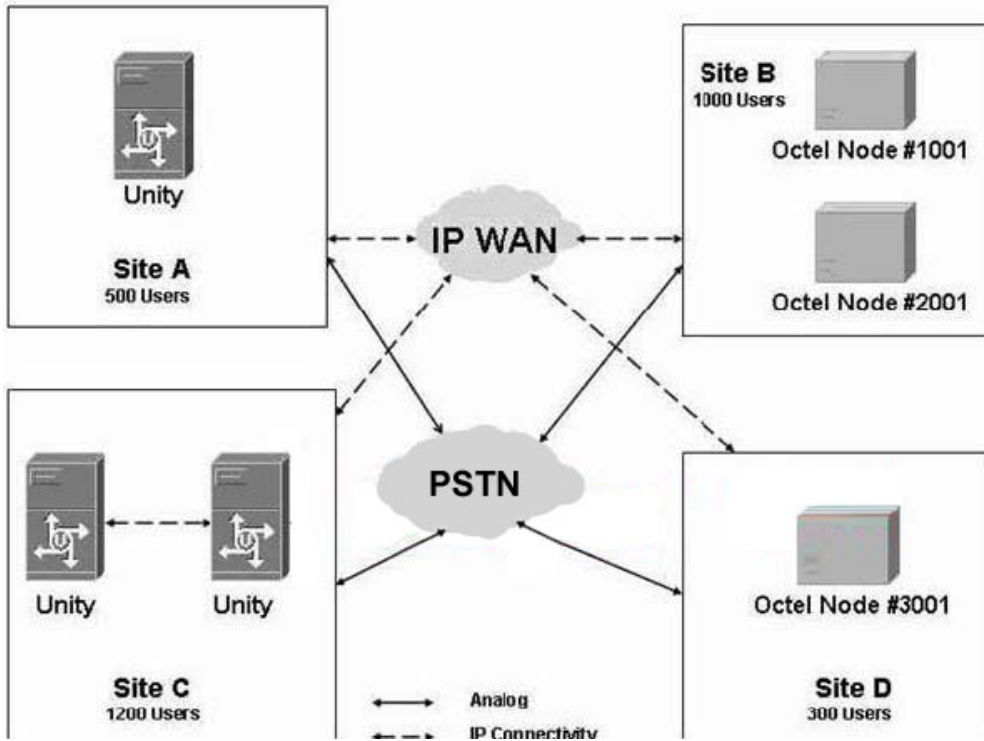

Certkiller .com deploys three Cisco Unity servers to provide messaging for their headquarters. They recently acquired Company B, which has a networked Octel voice mail system. Redundant OC-3 WAN connections have been provisioned for IP connectivity between all locations. You have been tasked with interconnecting the two voice mail system.

Referring to the exhibit, what is the best location for the deploying the bridge server?

- A. Site A
- B. Site B
- C. Site C
- D. Site D

Answer: B

QUESTION 133:

Your customer Certkiller .com has a 10,000 user voice mail only deployment. The TDM phone system (not a Cisco CallManager) that supports all the users is located in the Southern regional office and the telephone system integration uses a serial connection.

You have requested space for the Unity servers and they have assigned space in the

Northern regional office with the data servers. The bandwidth they have between the Southern and Northern regional office is dialup via analog lines.

Which statement is true?

- A. This solution will not work; you must provide T1 level bandwidth to redirect the serial integration data.
- B. This solution will work the phone system and the voice mail system do not need to be in the same location.
- C. This solution will not work; you must the phone system and the voice mail system in the same location.
- D. This solution will work; the phone system and the voice mail system can use the analog dialup connection to communicate with each other.

Answer: C

QUESTION 134:

You have been asked to design a large Automated Attendant Unity solution for a local university that can process 250 calls simultaneously. The outside callers must be offered a spell by name menu that includes all faculty and administrative people. Which configuration best meets the customer's requirements?

- A. four 72-port Cisco Unity servers configured in one Active Directory domain and one dialing domain with the directory handler search scope of each server set to that dialing domain
- B. three 72-port Cisco Unity servers configured in one Active Directory domain with one dialing domain with the directory handler search scope of each server set to that dialing domain
- C. four 72-port Cisco Unity servers configured in one Active Directory domain and one dialing domain with the directory handler server scope of each server set to the global address list
- D. three 72-port Cisco Unity servers configured in one Active Directory domain with one dialing domain, with the primary network location search scope of each server to the global address list.

Answer: A

QUESTION 135:

You are planning to deploy a voice mail only solution with a migration path to Unified Messaging. You are establishing Cisco Unity in your own forest/domain What is the Cisco Unity Design Guide recommended exchange alias naming convention?

- A. Lastname.Firstname
- B. Firstname.Lastname

- C. match what already exists or is planned
- D. anything except what already exists or is planned

Answer: C

QUESTION 136:

Your customer Certkiller .com asks you to design a voice mail only Unity solution of their company of 4,000 people. They have four physical locations and the users are spread evenly across the four locations.

Certkiller .com has a custom build e-mail system that runs on UNIX. There is T3-level bandwidth in a mesh topology between the four locations. They have a fully networked phone system with a 5 digit dialing plan throughout all locations.

Certkiller .com want all the users to be in one directory listing. They also want outside callers to be able to navigate through the Automated Attended menu to a list of specific users based on location and department.

You are creating a new forest. At each location, there will be one DCGC, one Unity server, and one Exchange server.

What are three recommended ways to best meet the customer's directory requirements? (Choose three.)

- A. install Unity on all servers
- B. do not run forest prep on any of the servers
- C. Install Exchange 5.5 on the appropriate new servers
- D. Install Exchange 2000 on the appropriate new servers
- E. create distribution lists for all the necessary departments on all Unity servers
- F. Create distribution lists for all the necessary departments on one Unity server
- G. as Windows 2000 is installed at the three remaining locations, join the newly created forest

Answer: A, D, F

QUESTION 137:

Your customer Certkiller .com asks you to design a voice mail only solution that works with the current network topology. They have 11,000 users on an existing UNIX e-mail platform.

All data servers, including the new global catalog servers you will be installing, are behind the company firewall. They want to place the Unity servers in the public, unprotected area where there is no access to the DCGC or the Exchange server.

Which statement is true?

- A. You need to have them supply access behind the firewall to the Unity servers.
- B. The global catalog servers can be separated from the Unity servers, but you must have the Microsoft firewall tunneling software enabled on the DCGC and the Unity servers.
- C. You should have them supply access behind the firewall to a single Unity server and

set that Unity server up as the firewall bridgehead for the rest of the Unity servers.
D. This will not create any problems. In a voice mail only deployment is not important to place the Unity servers behind the firewall with the DCGC and Exchange servers.

Answer: A

QUESTION 138:

Your customer Certkiller .com asks you to create a voice mail only Unity solution for their company of 8,000 users. They have four geographical locations. They want all users to be in one directory listing and they want outside callers to be able to locate all users by spelling the name of the user.

The four locations are referred to as sites A, B, C and D. Site A is the company's corporate headquarters and is home to 5,000 users. Site B has 2900 users and site C and D both have 20 users. They have a 5 digit dialing plan that connects all locations. Sites B, C, and D are each directly connected with Site A with a minimum of T1-level bandwidth.

Which solution best meets the customer's requirements?

- A. New forest/domain is created at site A and four 72-port Unity servers and four Exchange message stores are added. This site will be the centralized call processing site.
- B. At site A four 72-port Unity systems are installed and configured as four separate forest/domains. Each Unity is configured as the DCGC controller and one Exchange server is added to each forest domain. This site will be the centralized call processing site and service all four sites and 8,000 users.
- C. At site A, a new forest/domain is created and three 72-port Unity Servers and two Exchange message stores are added. At site B, a new forest/domain is created, one 72-port Unity server and one Exchange server are added as the mail store and forest replication connectors are set up. Site C and D users will be located on the equipment at site A.
- D. A new forest/domain is created at site A and three 72-port Unity servers and two Exchange message stores are added. At site B, one 72-port Unity server and one Exchange server are added as the mail store and one server is added as a local Domain controller and a global catalog server. Site C and D users will be located on the equipment at site A.

Answer: D

QUESTION 139:

Your customer Certkiller .com has 9,000 users. They request that you configure a voice mail only solution.

Without planning for the domain controllers and global catalog servers, what is the minimum number of Exchange servers you need on which to locate the users?

A. 1

- B. 2
- C. 3
- D. 5

Answer: C

QUESTION 140:

Your customer Certkiller .com asks you to design a Cisco Unity voice mail only solution to allow all outside callers at any of the 14 different company offices to locate any of the 7,500 users by simply spelling the name of the user via the touch tone telephone keypad in an Automated conversation.

Each office has a different voice mail system that you will be replacing with the new Unity solution. Each office also has a separate phone system. The phone systems come from various manufacturers.

Users dial a 10 digit phone number for each user to reach them. There is no telephone system networking between offices. Many of the phone systems will not allow conferencing and have a limited number of trunks for each office. The customer is not willing to change out the phone system structure at this time.

Which solution best meets Certkiller .com's requirements?

- A. This can be done with Voice Processing Internet Management (VPIM), which is an industry standard that allows different phone systems to integrate over the Internet.
- B. This can easily be done with the optional Cisco Unity PBX conference feature that allows transfers between different PBX's by using the Intel Dialog Voice Cards installed in all Unity servers.
- C. You explain to the customer that you can network the Unity systems together for subscriber to subscriber messaging, but to fulfill the requirements they want for Automated Attendant transfers between offices they need to change to a networked phone system solution.
- D. A new forest/domain is created and one Unity system is added at each office. All Unity systems are member servers in the forest/domain and are provisioned for the number of users at that site. On one Unity server, a dialing domain is created and all other Unity servers join that dialing domain. The directory handler search scope is set to that dialing domain.

Answer: C

QUESTION 141:

Your customer Certkiller .com asks you to design a voice mail only solution that works with the current network topology. They have 14,000 users on a UNIX-based e-mail platform.

All data servers, including the new Active Directory domain controllers you will be installing, are behind the company firewall. They want to place the Unity servers in the phone room with the TDM telephone system where there is no network access

from behind the firewall.
Which statement is true?

- A. This will not create any problems.
- B. The Active Directory servers can be separated from the Unity servers.
- C. You should have them supply access to the network from behind the firewall to the phone room for all the Unity servers.
- D. You should have them supply access to the network from behind the firewall to the phone room for one of the Unity servers and set up that Unity server as the firewall bridgehead for the rest of the Unity servers.

Answer: C

QUESTION 142:

Your customer Certkiller .com asks you to control the number of Cisco Unity ports that can be used with the Unity Inbox. They have invested in new speaker and microphone accessories for all Unity Inbox users. They want to eliminate the use of the Unity ports for Unity Inbox access.
Which solution meets this requirement?

- A. use the Tools Depot Advanced Settings tool, disable the dial out for client apps option
- B. using the System Administrators tool, go to the ports section and disable TRaP on all ports
- C. using the System Administrators tool, go to the COS section and disable the TRaP option for all Unity Inbox users
- D. use the Tools Depot Advanced Settings tool, go to the System resources choices and disable the Media Interface Utility systemwide

Answer: B

QUESTION 143:

Your customer Certkiller .com asks you to design a Unity voice mail only deployment. The location of all phone equipment will be on the customer-provided VLAN named "Voice".

The customer has a separate VLAN for all data servers including the new Exchange servers they have provided for the message stores that Cisco Unity will use. This VLAN is called Data. The current topology design puts the Unity servers in the Voice VLAN and the Exchange servers in the Data VLAN.

Considering best practices, which statement about this configuration is true?

- A. The Unity servers should be moved to the same VLAN the Exchange servers are on.
- B. The VTL management protocol should be added to assist in crossing between VLANs.
- C. Spanning Tree Protocol should be added to the Voice VLAN and a one-way window scope should be set for the IP addresses of the Exchange servers.

D. Spanning Tree Protocol should be added to both VLANs and a two-way window scope should be set for the IP addresses of the Unity servers and the Exchange servers.

Answer: A

QUESTION 144:

Your customer Certkiller .com asks you to design a large Unified Messaging Cisco Unity solution for their 8,000 users. They are currently upgrading all of the sites into one Domino Domain with Lotus Domino as the standard for all e-mail servers. Certkiller .com will complete the upgrade in approximately ten months. They want a temporary voice mail solution with a clean migration path to Unified Messaging. How can you accomplish this?

- A. add new Unity and Exchange servers provisioned for the 8,000 users as part of the Domino domain, enable the IBM to MS directory conversion tools
- B. create a separate forest/domain with new Unity and Domino servers provisioned for the 8,000 users; use the user conversion wizard to add the new users.
- C. add new Unity and Domino servers provisioned for the 8,000 users as part of the Domino domain with voice mail only licenses; upgrade the licenses as the users are added to the Domino domain.
- D. create a separate forest/domain with new Unity and Exchange and Active Directory servers provisioned for the 8,000 users; when the new Domino domain upgrade is complete, reinstall all Unity servers into the Domino domain.

Answer: D

QUESTION 145:

Your customer Certkiller .com requires you to provide a Unity solution that will offer voice mail only today and a planned migration path to Unified Messaging in the next year. They have an existing Windows 2000 and Exchange 2000 configuration that supports their 12,000 users. At this time they do not allow the Windows 2000 Active Directory schema to be modified. How can you best meet the customer's requirements?

- A. install two Unity servers in the existing win2K domain and import the users
- B. install four Unity servers in the existing win2K domain and import the users
- C. create a separate forest/domain with new servers provisioned for the 12,000 users and use the same Exchange alias naming convention
- D. create a separate forest/domain with new servers provisioned for the 12,000 users and use a separate Exchange alias naming convention so there are no overlapping GUID issues

Answer: C

QUESTION 146:

Your customer Certkiller .com deploys Unity voice mail with Exchange 2000 as the message store in four sites. Each site uses a separate Exchange organization. They want to implement SMTP networking with blind addressing. Which three must be configured? (Choose three).

- A. locations
- B. location dial ID
- C. voice connector
- D. Internet subscribers

Answer: A, B, C

QUESTION 147:

The voice connector performs which task on outgoing SMTP messages?

- A. sets the address type to VOICE
- B. converts the message to MAPI format
- C. routes messages to the UOmni mailbox
- D. converts voice attachments to the G.729a audio format

Answer: A

QUESTION 148:

Exhibit

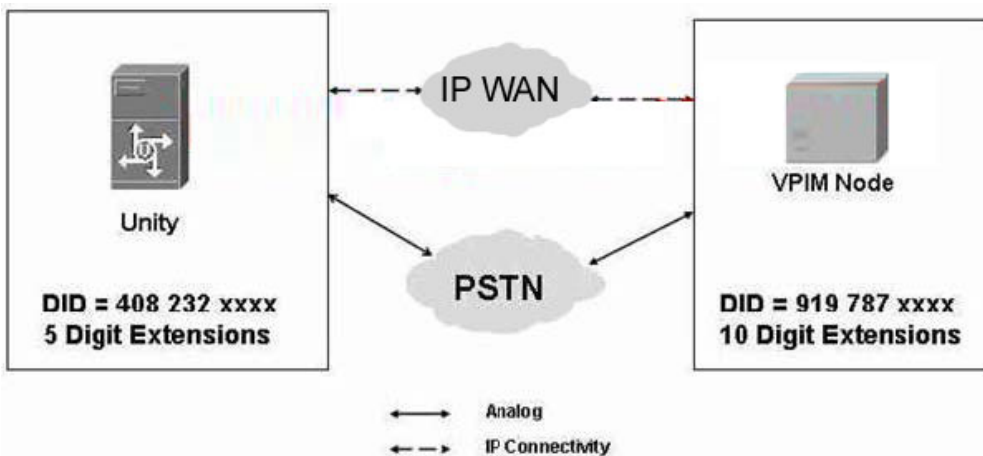

Certkiller .com needs to exchange voice messages with a supplier using VPIM. You are asked to provide dial by name and you want to maintain your internal 5 digit dialing plan.

You add VPIM subscribers using a 5 digit extension and a 5 digit remote mailbox number.

Because your supplier's voice mail system only supports blind addressing, they want

to use the full DID number to send messages to you.

Referring to the exhibit, which prefix should be configured in your Unity server's VPIM delivery location?

- A. Unity Prefix = 23
- B. Unity Prefix = 40823
- C. Remote Prefix = 78
- D. Remote Prefix = 91978

Answer: D

QUESTION 149:

Cisco Unity uses Active Directory to facilitate which three activities? (Choose three.)

- A. Unified Messaging
- B. remote notification
- C. voice mail networking
- D. Global Subscriber Manager (GSM)

Answer: A, C, D

QUESTION 150:

VPIM subscribers are stored in which Active Directory schema class?

- A. User
- B. Group
- C. Contact
- D. Unity Location

Answer: C

QUESTION 151:

Exhibit

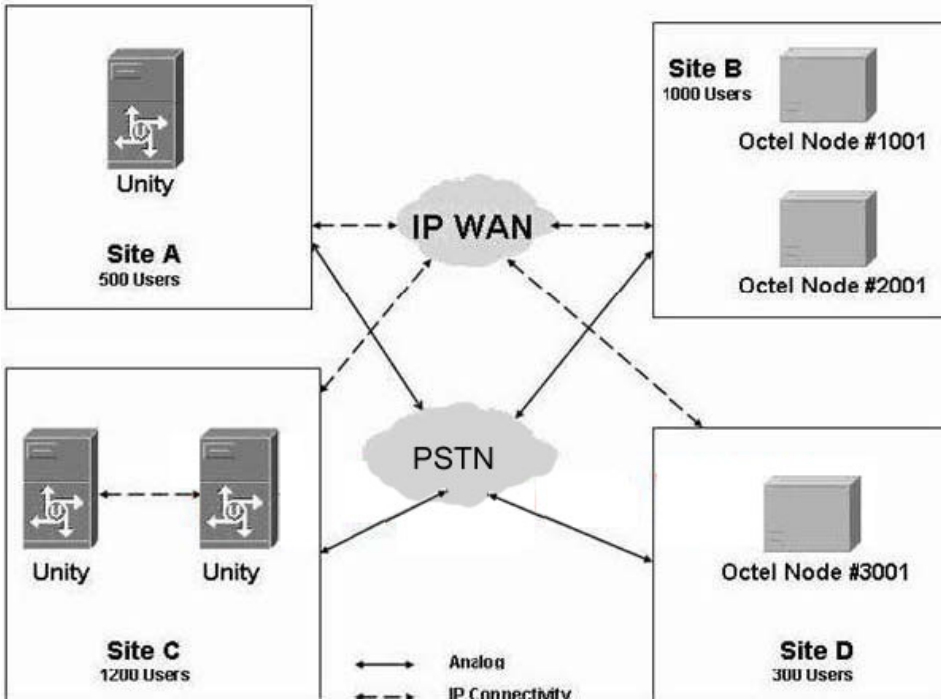

Certkiller .com deploys three Cisco Unity servers to provide messaging for their headquarters. They recently acquired Company B, which has a networked Octel voice mail system. There are 256k WAN connections that have been provisioned for IP connectivity between all locations. You have been tasked with interconnecting the two voice mail systems.

Referring to the exhibit, what is the best location for deploying the bridge server?

- A. Site A
- B. Site B
- C. Site C
- D. Site D

Answer: C

QUESTION 152:

What is required to support AMIS networking when Unity is integrated with Cisco CallManager?

- A. SMDI link to remote voice mail system
- B. IP connectivity to remove voice mail system
- C. specific Active Directory schema extensions
- D. a voice gateway that supports fourth-column DTMF

Answer: D

QUESTION 153:

Certkiller .com is replacing their voice mail system with a Cisco Unified Messaging system. They have 2,000 employees at their headquarters location, 800 employees at their data center, and 1,000 employees spread across 80 branch locations.

Headquarters has redundant OC-3 connections to the data center and is using a Nortel PBX. They have recently deployed a Cisco CallManager cluster at the data center that provides centralized call processing for the branch locations. The features they must continue to have are:

1. Saved messages are deleted after 14 days.
2. Outside callers can always dial 0 to get to an operator.
3. There is a layered menu of choices from the Automated Attendant (press one for sales, when they press 1 they get a second layer to choose which products they want sales for).
4. New messages are never deleted.
5. There are 48 ports of voice mail / Auto Attendant.
6. Holiday Greetings are prerecorded up to a year in advance.

The customer needs to know what features and functions will be different with the new Cisco Unity as compared to the old voice mail system.

Which features will continue to function the same way in the new Cisco Unity?

- A. 1 4 5
- B. 1 2 3 4
- C. 2 3 4 5
- D. 1 3 4 5 6
- E. 1 2 3 4 5 6

Answer: C

QUESTION 154:

Certkiller .com is seeking proposals to replace their voice mail system. Their initial plans are to install a voice mail system and later migrate to Unified Messaging when they have completed a planned Microsoft Exchange deployment.

They have 4,000 employees at their headquarters location and 1,000 employees at their 80 branch locations. They have recently deployed a centralized Cisco CallManager cluster to support their branch locations and will soon begin migrating their headquarters to Cisco IP Phones. The voice mail system must provide Automated Attendant and MWI for the IP Phones and the existing Nortel PBX.

The preliminary design proposal for the customer calls for a voice mail only deployment with an off-box message store to facilitate migration to Unified Messaging. The initial Bill of Materials includes:

- 1 Unity server
- 1 Unity failover server
- 5000 VM licenses

1 Exchange 2000 server

Which two additional pieces of equipment are required to meet the customer's requirements? (Choose two).

- A. Unity server
- B. VPIM license
- C. Unity failover server
- D. Exchange 2000 server
- E. Intel Dialogic (TM) voice boards

Answer: D, E

QUESTION 155:

A car dealership is configuring Unity as an Automated Attendant. The requirements are for outside callers to hear a prompt saying Press 1 for Sales, Press 2 for Service. If they press 1, they reach a submenu where they are prompted to press 1 for New Car Sales, Press 2 for Used Car Sales and Press 3 for parts. If they press 2, they reach a submenu where they are prompted to Press 1 to schedule an appointment and Press 2 to reach your Service Advisor. If the caller presses 2 from the Service submenu, Unity should list each of the three Service Advisor's names and allow the caller to choose. At any time the caller is able to press 0 and be transferred to the operator.

What is the minimum number of call handlers required?

- A. 6
- B. 8
- C. 10
- D. 12

Answer: B

QUESTION 156:

A university is deploying Cisco Unity. There will be three students in each dormitory room with a single phone number. They want the students to be able to record individual greetings.

What is the minimum configuration necessary, per dormitory room, in addition to three subscribers, to meet these requirements?

- A. one call handler
- B. three call handlers
- C. one interview handler
- D. one directory handler

Answer: A

QUESTION 157:

Some Cisco Unity Unified Messaging users complain that they cannot use the telephone for the recording and playing of messages through their desktops. What is a possible cause for this?

- A. A firewall separates these users from Cisco Unity.
- B. These users are not licensed for Unified Messaging.
- C. These users need to have their Exchange mailboxes modified to allow access.
- D. The Unity server does not have a sufficient number of Unified Messaging licenses.

Answer: A

QUESTION 158:

Domino Unified Communications (DUC) Services must be installed on which servers in a Cisco Unity/Lotus Domino messaging environment?

- A. all Cisco Unity servers in the domain
- B. all Lotus Domino servers in the domain
- C. only the Cisco Unity Partner Domino server
- D. Lotus Domino servers hosting Cisco Unity subscribers

Answer: D

QUESTION 159:

In which messaging configuration must the schema be extended for Cisco Unity?

- A. Lotus Domino
- B. Exchange 5.5
- C. Exchange 2000/2003
- D. Domino/Exchange mixed-mode

Answer: C

QUESTION 160:

In a Cisco Unity failover configuration, which component replicates the database between the primary and secondary servers?

- A. MSDE
- B. SQL 2000
- C. DB connector
- D. directory replication connector

Answer: B

QUESTION 161:

Which Cisco Unity component does Veritas Backup Exec back up that the Disaster Recovery Tool (DiRT) does not?

- A. routing rules
- B. SQL database
- C. operating system
- D. off box messages

Answer: C

QUESTION 162:

The Cisco Security Agent (CSA) can be installed on to the Cisco Unity server to _____

- A. "harden? the server
- B. force password changes for security
- C. prevent forwarding of private messages
- D. provide additional authentication for Unity Inbox users

Answer: A

QUESTION 163:

When installing Cisco Unity into a Lotus Domino messaging environment, one requirement is to install at least one Cisco Unity server per Domino _____

- A. site
- B. domain
- C. nsf group
- D. routing group

Answer: B

QUESTION 164:

Your customer Certkiller .com is connected about security on their Cisco Unity Unified Messaging Installation.

Which two steps can they take to improve security? (Choose two).

- A. install antivirus software

- B. perform a nightly backup
- C. keep voice mail messages on box
- D. install Cisco Unity's Security Agent software
- E. isolate Cisco Unity behind a separate firewall

Answer: A, D

QUESTION 165:

The Unity Active Directory schema extension is run on which server?

- A. Cisco Unity server only
- B. Windows 2000 Schema Master
- C. Exchange 5.5 Raw Schema server
- D. Windows 2000 Primary Domain Controller

Answer: B

QUESTION 166:

A pet supplies retailer Certkiller .com was founded in 1998 and has been expanding at a gradual pace. Certkiller .com has twelve existing location throughout the western United States. It plans to implement the Cisco Unity messaging solution over the coming months. This Unity system will integrate with Cisco CallManager v3.3. They installed a Cisco CallManager cluster at the hosting center before the first store opened.

The Certkiller .com network uses Microsoft Windows 2000 servers at the central hosting center, with Windows XP PC's at the stores. There is a single forest and a single domain. All domain controllers, global catalog servers, and DNS servers reside at the hosting center. There are several database servers for inventory management at the hosting center.

Each store has dual T1's terminating at the hosting center via newly installed 3756 routers. The 3745 routers were selected because of their scalability. The switched infrastructure at each store is a single 48- or 24-port Cisco 3550 switch.

All store locations use the single CallManager cluster, two MCS-7835 servers, all located at the hosting center. Currently, most calls are to other store or to the hosting center. The IT department is going to use the 3745 routers for SRST and PSTN connections. They will configure the 3745 to provide DTMF access to the Unity server via the PSTN.

Which recommendation would you make to ensure access to voice mail and the PSTN during a network outage?

- A. This design will work. Nothing further needs to be done.
- B. connect the 3745 routers to the PSTN with BRI lines to provide digital service to Cisco Unity during a network outage
- C. replace the 3745 routers with a set of 3550 switches and PRI lines to provide digital

service to Cisco Unity during a network outage.

D. replace the 3745 routers with 3550 switches, use those for SRST and PSTN connections, configure the 3550's to provide DTMF access to the Unity server via the PSTN.

Answer: A

QUESTION 167:

Exhibit

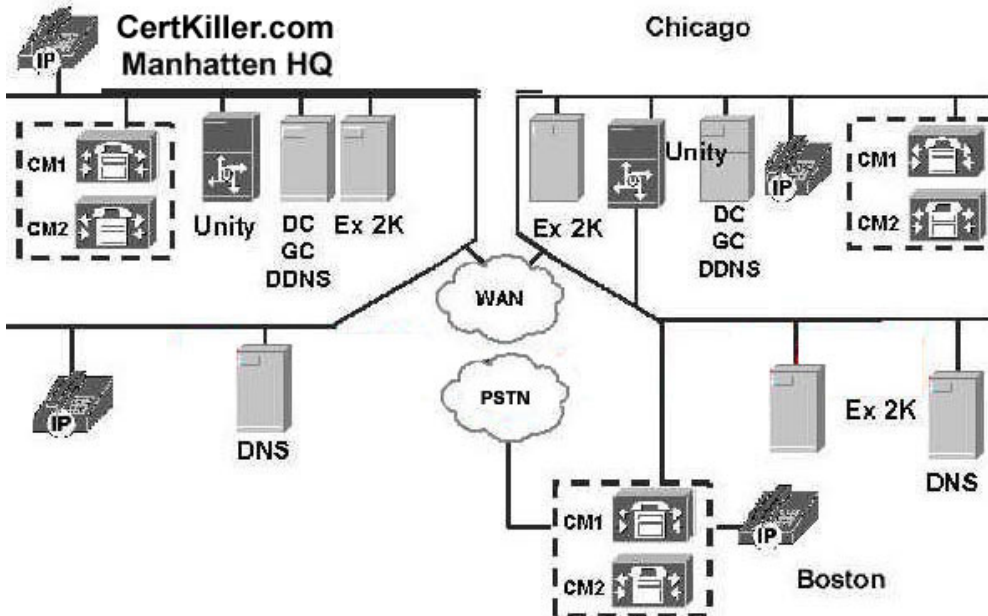

Certkiller .com is a fast-growing electronics retailer. This corporation was founded in 2001 and has been expanding rapidly. It has 21 existing locations throughout the midAtlantic states. Certkiller .com plans to implement the Cisco Unity messaging solution over the coming months. This Unity system will integrate with Cisco CallManager v3.3. They will start with a voice mail only installation and move to Unified Messaging in the next fiscal year.

Certkiller .com uses Cisco routers, switches and firewalls. They installed a Cisco CallManager cluster at the hosting center before the first store opened.

The corporate network uses Microsoft Windows 2000 servers at the central hosting center Windows XP PC's at the stores. There is a single forest and a single domain. All domain controllers, global catalog servers, and DNS servers reside at the hosting center. There are several database servers for inventory management at the hosting center.

Each store has dual T1's terminating at the hosting center via newly installed 3745 routers. The 3745 routers were selected because of their scalability. The switched infrastructure at each store is a single 48- or 24-port Cisco 3550 switch.

All store locations use the single CallManager cluster, two MCS-7835 servers, located at the hosting center. Currently, most calls are to other stores or the hosting center. Locations are configured to allow three concurrent calls over the WAN from

each store.

The exhibit shows a simplified design proposal. Though only one store is shown, all the other stores will utilize this design. The proposal is to put Cisco Unity in its own forest with its own directory. When it comes time to migrate to Unified Messaging, the DiRT tool will be used.

What should be added or changed in the proposal to facilitate a successful future migration to Unified Messaging?

A. When adding subscribers to each of the Cisco Unity servers, each Exchange alias should match those in use in Exchange. The Disaster Recovery Tool (DiRT) backup and restore process will locate the target mailbox using the alias.

B. When adding subscribers to each of the Cisco Unity servers, each Exchange alias should have VM_ prepended to existing names in use in Exchange. Migrate Subscriber Data and ExMerge are used to move Unity-specific attributes and messages after a Disaster Recovery Tool (DiRT) backup and restore.

C. When adding subscribers to each of the Cisco Unity servers, Exchange aliases must not match those in use in Exchange. The names from the global address book are hidden. Migrate Subscriber Data and ExMerge are used to move Unity-specific attributes and messages after a Disaster Recovery Tool (DiRT) backup and restore.

D. Nothing needs to be done to the design to make migration to Unified Messaging easier. Any Exchange alias can be used. The Migrate Subscriber Data Tool and ExMerge are used to move Unity-Specific attributes and messages after doing a Disaster Recovery Tool (DiRT) backup, upgrading the Unity software, then restoring the DiRT backup.

Answer: A

QUESTION 168:

Exhibit

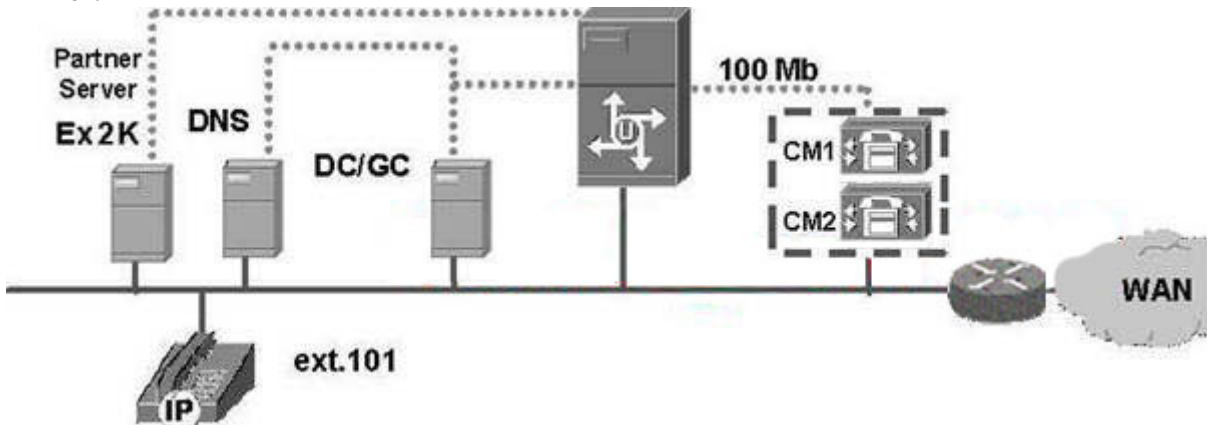

Given the information shown in the exhibit and knowledge that hardware transcoders are installed on the routers, which codec should be used by the Cisco Unity server for prompts and message record format?

A. G.711

B. G.726

C. G.729a
D. GSM 6.10

Answer: A

QUESTION 169:

Exhibit

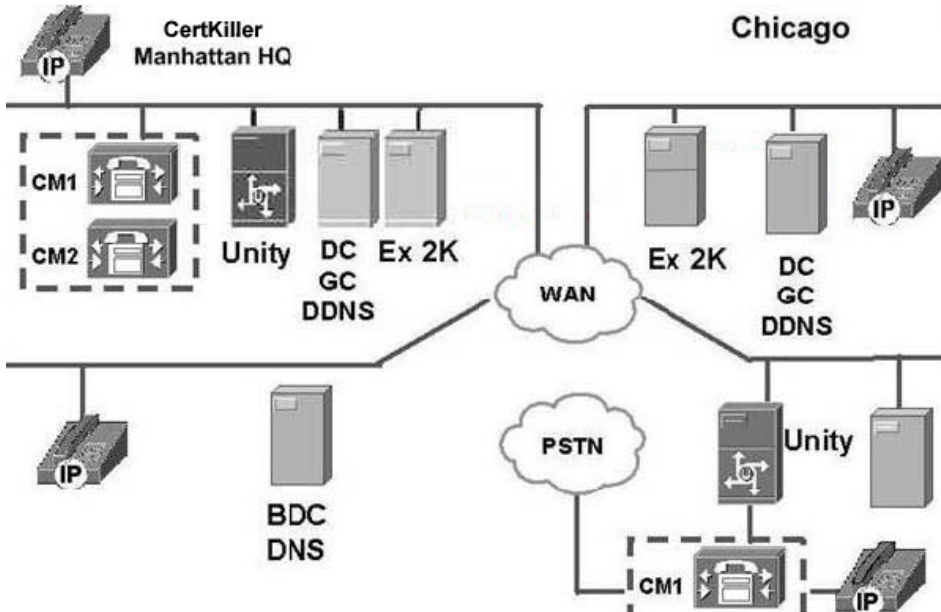

Certkiller .com will be implementing the Unity messaging solution over the coming months. The initial deployment is going to be voice mail only but will migrate to Unified Messaging within 12 months. This company is one of the world's largest brokerage firms. The corporation was founded in 1956 and has been known for providing advanced communication services to its brokers ensuring the fastest and most reliable communication.

Since the company's inception in 1956 it has expanded from its headquarters (HQ) in Manhattan adding offices in seven US cities and five international locations. The Manhattan HQ still has the largest number of employees (3,500). The other US cities are Chicago (1,200 employees), Miami (450 employees), Boston (820 employees), Dallas (350 employees), Seattle (350 employees), Los Angeles (1,100). The international locations are Madrid, Spain (300), London, England (200 employees), Paris, France (300 employees), Tokyo, Japan (450 employees), and Kuala Lumpur, Malaysia (500 employees).

The company has installed Cisco CallManager clusters at each location. The corporate network uses Microsoft Windows 2000 Active Directory.

There are two forests. The root domain in the first forest is cns.com. There is a second domain in the forest called cns.internal. The second forest root is cnsasia.com. It is the only domain in the forest.

There are redundant domain controllers and global catalog servers at each location. DNS and DHCP servers are also found at each location.

The HQ site has two OC-48 connections using HSRP. All sites have redundant T3;s

using HSRP to the HQ along with a T1 to every location, providing a fully meshed architecture.

The company uses an Exchange 2000 messaging platform. There are no planned upgrades to Exchange 2003 at this time.

There are two Exchange organizations. Org 1 includes all North American and European servers and Org 2 includes all Asian servers. Both organizations use a single routing group. Org 2 has each city's Exchange servers in a unique administration group, while Org 1 has a single administration group. Each office has local Internet connectivity, and each office maintains its own Exchange servers. As part of your proposal, you recommend that when adding new subscribers to each of the Cisco Unity servers, their user names not match those in use in Exchange. These names should also be hidden from the global address book. Also, licensing should be changed from voice mail to Unified Messaging.

What should be added or changed in the proposal to complete the migration to Unified Messaging?

(Use the exhibit to help determine the correct answer. It does not show all sites.)

- A. Nothing more needs to be done to migrate to Unified Messaging in the future.
- B. When adding subscribers to each of the Cisco Unity servers, user names should match those in use in Exchange, otherwise the proposal is fine.
- C. The Unity Migrate Subscriber Data tool and Microsoft's ExMerge should be used to move Unity-specific attributes and messages to complete the migration.
- D. User names should match those in use in Exchange. The names do not need to be hidden from the global address book. The Disaster Recovery Tool (DiRT) Backup and Restore process is used to finish the migration successfully.

Answer: C

QUESTION 170:

Exhibit

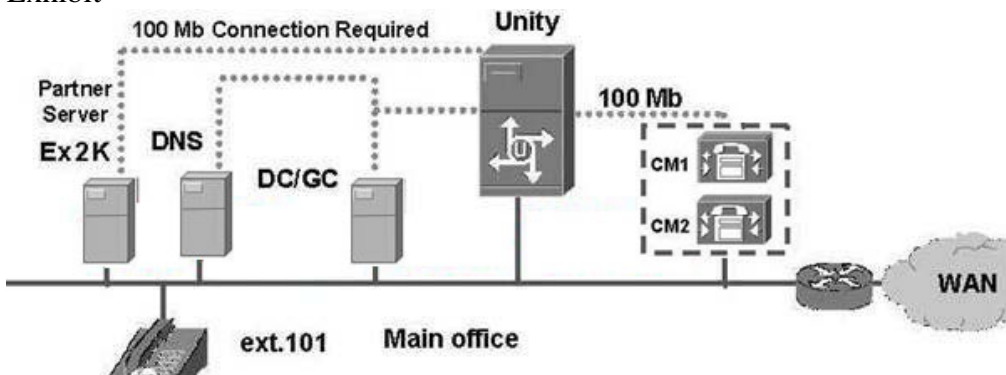

The routers shown in the exhibit have hardware transcoders installed between the main office and the branch office. Your design goal is to make the most efficient use of the single Cisco Unity server installed in the main office.

A. G.711

- B. G.726
- C. G.729
- D. GSM 6.10

Answer: A

QUESTION 171:

Certkiller .com is one of the world's largest brokerage firms. This corporation was founded in 1956 and is known for providing advanced communication services to its brokers, ensuring the fastest and most reliable communication. The company currently has over 10 million customers who trust them for the buying, selling, and trading of mutual funds, stock, and precious metals.

The Company Headquarters (HQ) is located in Manhattan. It has offices in seven cities in the United States and five international cities. HQ has 3500 employees. Other U.S. locations include the Chicago office (1,200 employees); Miami (450 employees); Boston (820 employees); Dallas (350 employees); Seattle (350 employees); and Los Angeles (1,100 employees). International locations include Madrid, Spain (300 employees); London, England (200 employees); Paris, France (300 employees); Tokyo, Japan (450 employees); and Kuala Lumpur, Malaysia (500 employees).

Certkiller .com uses Cisco routers, switches, firewalls and intrusion detection and has installed Cisco CallManager clusters at all locations. The corporate network uses Microsoft Windows 2000 Active Directory.

There are two forests. The first forest has two root domains: coa.com and coa.internal. The second forest root has only one domain, coasia.com.

There are redundant domain controllers and global catalog servers at each location. DNS and DHCP servers are also found at each location. The HQ site has two OC-48 connections using HSRP. All sites have redundant T3's using HSRP to the HQ along with a T1 to every location, providing a fully meshed architecture.

Certkiller .com uses an Exchange 2000 messaging platform. There are no planned upgrades to Exchange 2003 at this time.

There are two Exchange organizations: Org 1 includes all North American and European servers and Org 2 includes all Asian servers. Both organizations use a single routing group. Org 2 has each city's Exchange servers in a unique administration group, while Org 1 has a single administration group. Each office has local Internet connectivity, and each office maintains its own Exchange servers. Certkiller .com just upgraded to Cisco CallManager at all locations. Two MCS-7835 servers are located at each site, except HQ, which has three MCS-7835 servers.

There are inter-cluster trunks established between all subscribers in all clusters. Certkiller .com likes to route all intra-company calls over their 3DES network links. The existing voice messaging platform was provided by several different vendors and there is no networking between them.

Certkiller .com plans to change voice messaging platforms at all locations to Cisco Unity. The system will initially be voice mail only, but will switch to Unified Messaging during the next fiscal year.

Which deployment model will work best among all the offices?

- A. centralized call processing; centralized messaging
- B. centralized call processing; distributed messaging
- C. distributed call processing; centralized messaging
- D. distributed call processing; distributed messaging

Answer: D

QUESTION 172:

Certkiller .com is a nationwide company employing 10,000 people. Its headquarters is in Seattle, Washington. It has offices in most major cities and it maintains two large data centers in Seattle, Washington and Chicago, Illinois.

Certkiller .com is replacing its 43 Octel voice mail servers by deploying 15 Cisco Unity servers into the two data centers. These centers will provide service to the many sales and development offices scattered throughout the regions they serve. A hub-and-spoke design will be built in each region they serve, with a high-speed backbone connecting the centers.

Given the number of employees, it is impractical to have outside callers and subscribers search the entire global address list as a first step in locating an employee whose telephone number they do not know. The Certkiller .com goal is to provide easy directory service to each local office, then move to the global address list if the lower level search is not successful. The IT department has decided to provide all local offices with distinct phone numbers and build call routing rules that direct callers to an opening greeting for each office.

What is the most effective way to limit directory search scope?

- A. put all employees in each office into a separate distribution list; build a directory handler for each office; limit directory searches with that office's distribution list
- B. install Platform Overlay 5 servers at all locations with the maximum amount of memory and four processors; build one directory handler for each of the data center locations; build a distribution list; make each employee served by that data center a member of the list; use that list to limit searches in the directory handler
- C. make employees members of a distribution list based on the department they work in; build a series of directory handlers that use membership in those distribution lists as the limit on the search; build a call handler that offers callers the ability to search based on the department an employee works in; use one-key dialing to provide access to the correct directory handler
- D. build a series of directory handlers that break the entire employee list into manageable-sized, alphabetically-ordered chunks; make employees members of a distribution list based on the first letter of their last name that mirrors the chunks of the alphabet of the directory handlers; use that distribution list to limit directory searches; build a call handler that offers callers the ability to search based on the initial letter of an employee's last name; use one-key dialing to provide access to the correct directory handler

Answer: A

QUESTION 173:

Certkiller .com is one of the world's largest brokerage firms. This corporation was founded in 1956 and is known for providing advanced communication services to its broker, ensuring the fastest and most reliable communication. The company currently has over 10 million companies who trust them for the buying, selling, and trading for mutual fund stocks and precious metals.

Company Headquarters (HQ) is located in Manhattan. It has offices in seven cities in the United States and five international cities. HQ has 3500 employees. Other U.S. locations include the Chicago office (1,200 employees); Miami (450 employees); Boston (820 employees); Dallas (350 employees); Seattle (350 employees); and Los Angeles (1,100 employees). International locations include Madrid, Spain (300 employees); London, England (200 employees); Paris, France (300 employees); Tokyo, Japan (450 employees); and Kuala Lumpur, Malaysia (500 employees). Certkiller .com uses Cisco routers, switches, firewalls and intrusion detection and has installed Cisco CallManager clusters at all locations. The corporate network uses Microsoft Windows 2000 Active Directory.

There are two forests. The first forest has two root domains: coa.com and coa.internal. The second forest root has only one domain, coasia.com.

There are redundant domain controllers and global catalog servers at each location. DNS and DHCP servers are also found at each location. The HQ site has two OC-48 connections using HSRP. All sites have redundant T3's using HSRP to the HQ along with a T1 to every location, providing a fully meshed architecture.

Certkiller .com uses an Exchange 2000 messaging platform. There are no planned upgrades to Exchange 2003 at this time.

There are two Exchange organizations: Org1 includes all North American and European servers and Org2 includes all Asian servers. Both organizations use a single routing group. Org2 has each city's Exchange servers in a unique administration group, while Org1 has a single administration group. Each office has local Internet connectivity, and each office maintains its own Exchange servers.

Certkiller .com just upgraded to Cisco CallManager at all locations. Two MCS-7835 servers are located at each site, except the HQ, which has three MCS-7835 servers.

There are inter-cluster trunks established between all subscribers in all clusters.

Certkiller .com likes to route all intra-company calls over their 3DES encrypted network links. The existing voice messaging platform was provided by several different vendors and there is no networking between them.

Certkiller .com plans to change voice messaging platforms at all locations to Cisco Unity. The system will initially be voice mail only installed in its own forest/domain, but will switch to Unified Messaging during the next fiscal year. Unity servers will be deployed at each office in a decentralized call processing.

Which best practices naming convention should you use for subscribers on the voice mail implementation to ensure the most efficient transition to Unified Messaging?

- A. make the user name on each subscriber's voice mail account identical to the one on their current Exchange account
- B. use any naming convention; Cisco Unity's Move Subscriber Data tool is capable of handling any difference in account names
- C. make the user name on each subscriber's voice mail account similar to the one on his current Exchange account, just add the suffix "vm"
- D. make the user name on each subscriber's voice mail account similar to the one on his current Exchange account, just add the prefix "m_"

Answer: A

QUESTION 174:

An advertising agency with offices in New York, Chicago, Atlanta, and Los Angeles wants to modernize its communications infrastructure. Each office has operated independently in the past. Recently, the company obtained more national and multi-national clients, so the need to communicate closely between offices has gained strategic significance to the company.

Each office currently maintains its own PBX, e-mail, and voice mail systems. The company has determined that it will implement a centralized Cisco CallManager/centralized Cisco Unity solution as a replacement for the disparate systems in a phased approach.

Management is meeting resistance from the Los Angeles office, which purchased a new NEC NEAX 2400 just six months ago. Their voice mail can be replaced but it will be several years until the PBX is fully depreciated, so the completely centralized Unity solution will wait until then.

The IT department is building a data center in Chicago where it will maintain a CallManager cluster providing service to New York, Atlanta and Chicago. There is a single forest and a single domain. All domain controllers, global catalog servers, and DNS servers reside at the data center. Cisco Unity and Microsoft Exchange servers will be installed at the Chicago data center and the Los Angeles office. Each office has dual T3's terminating back at the data center via newly installed 3745 routers. The 3745 routers were selected because of their scalability. The switched infrastructure at each office consists of 48-port Cisco 3550 switches. Each office currently has a four-digit plan in the 1000-?999 range.

Which best practice dialing plan design should you implement to enhance current communication and ease the transition to a fully centralized solution?

- A. leave all extensions in the 1000-?999 range; put each of the Unity servers in their own dialing domain; use alternate extensions on all the Unity servers to simplify message addressing
- B. leave all extensions in the 1000-?999 range; give each of the Unity servers a unique location ID; enable the "Play Location to Subscriber as Part of Search Results" setting; train users to enter a location number when dialing outside their own office.
- C. leave the Chicago extensions in the 1000-?999 range; renumber New York in the 2000-?999 range; Atlanta in the 3000-?999 range; and Los Angeles in the 4000-?999

range; put the Unity servers providing service to Chicago, New York and Atlanta in the same dialing domain

D. leave the Chicago and Los Angeles extensions in the 1000-?999 range; put each server into its own dialing domain; renumber New York and Atlanta in the 2000-?999 and 3000-?999 ranges; use alternate extensions on all the Unity servers to simplify message addressing

Answer: C

QUESTION 175:

Certkiller .com plans to implement the Cisco Unity messaging solution over the coming months. This Unity system must integrate with Cisco CallManager v3.3 and network with the existing Octel System until all stores are moved over to Unity. Certkiller .com expects the process to take six months. The company currently has 21 stores and is adding an average of five stores each year. The IT department will not create Unity Bridge subscriber accounts for all store employees, but will let Octel's NameNet emulation create new directory entries at the time of the first call. After Cisco Unity and the Unity Bridge have been installed and operating for two months, which statement is true about availability of addresses?

- A. The addresses of all subscribers are available to all callers.
- B. The addresses of all subscribers are available to subscribers, but not outside callers.
- C. The addresses of all subscribers who have been messaged in the last 60 days are available to subscribers and outside callers
- D. The addresses of all subscribers who have been messaged in the last 30 days are available to subscribers and outside callers.

Answer: D

QUESTION 176:

Certkiller .com is an aftermarket automotive parts supplier that maintains its corporate headquarters in Torrance, California and manufacturing plants in Bakersfield, California, Tulsa, Oklahoma, and Atlanta, Georgia. All network and phone services are provided from a hosting center located at corporate headquarters.

In 2002 they installed a Cisco CallManager cluster in the hosting center and Cisco Unity to provide voice mail for all employees. Headquarters employees' phone extensions are in the 1000-?000 range. Tulsa employees are in the 3000 range. Bakersfield employees are in the 4000 range and Atlanta employees occupy the 5000-6000 range. Cisco Unity and Exchange servers are located at each facility. The corporate network uses Microsoft Windows 2000 servers at the central hosting center with Windows XP PC's at the plants. There is a single forest and a single domain. All domain controllers, global catalog servers, and DNS servers reside at the hosting center.

Each plant has dual T3's terminating back at the hosting center via newly installed 3745 routers. The switched infrastructure at each store is a single 48-port Cisco 3550 switch.

Recently, Certkiller .com acquired Company K, another automotive parts supplier. One of their first moves was to install Cisco Unity to replace the 6 year old voice mail server with which the Company K management and employees had become increasingly frustrated. The NEC NEAX 2400 PBX providing phone service at the Company K has extensions in the 1000-?000 range.

What is the most effective way to use Cisco Unity to fix the overlapping dial plan so that all of Certkiller .com's employees can voice message each other?

- A. reprogram the Company K NEAX 2400 to provide extensions in the 7000?000 range
- B. put the headquarters and Tulsa Unity servers into a dialing domain to segment the dialing plan
- C. put the Bakersfield, Tulsa, and Atlanta servers into a dialing domain to segment the dial plan and guard against future overlap
- D. replace all of the telephones and network wiring at Company K so they can use the Cisco CallManager at the hosting center with extensions in the 7000?000 range

Answer: B

QUESTION 177:

A customer Certkiller .com has 22,000 users. Approximately 15,000 users are located at a centralized campus area and remaining 7,000 user are distributed across 20 separate remote locations.

All services are distributed across the environment, including telephony and messaging. Of the twenty remote locations, ten have a maximum of 15 users and a T1 WAN connection to the data center located at the centralized campus. The remaining remote sites have a maximum of 750 users and T3 WAN connections. The customer wants Unified Messaging and wants to use text to speech. They also plan to provide all users with View Mail For Outlook (VMO).

Given this information, which statement is true about VMO and remote users?

- A. All remote users should NOT use VMO because it cannot be remotely installed.
- B. The remote VMO clients should be configured via Class of Service (COS) to only allow download before playback, and Telephone Record and Playback (TRaP) should not be used for the remote clients.
- C. The remote VMO clients should be configured to allow for Telephone Record and Playback (TRaP) sessions and for streaming of messages from the VMO client (default configuration).
- D. The remote VMO clients can use Telephone Record and Playback (TRaP), but the administrator needs to configure each individual's preference for playback (download first or stream direct to the desktop from the mail store).

Answer: C

QUESTION 178:

In all distributed messaging configurations, Unity must be collocated with CallManager first, so it will use the call processing deployment model first and then the messaging deployment model.

How does this affect a customer if they collapse their distributed messaging configurations to a centralized model?

- A. A centralized model will be satisfied with Unity collocated with either CallManager or the messaging servers.
- B. All Unity servers are able to continue to run and physically remain in their present location even while the messaging servers are moved.
- C. In any messaging deployment model, Unity must be collocated with the messaging systems and then consideration must be given to CallManager.
- D. All Unity servers must be taken offline and remain in their present location while the messaging servers are moved from the remote locations to the centralized location.

Answer: C

QUESTION 179:

Exhibit

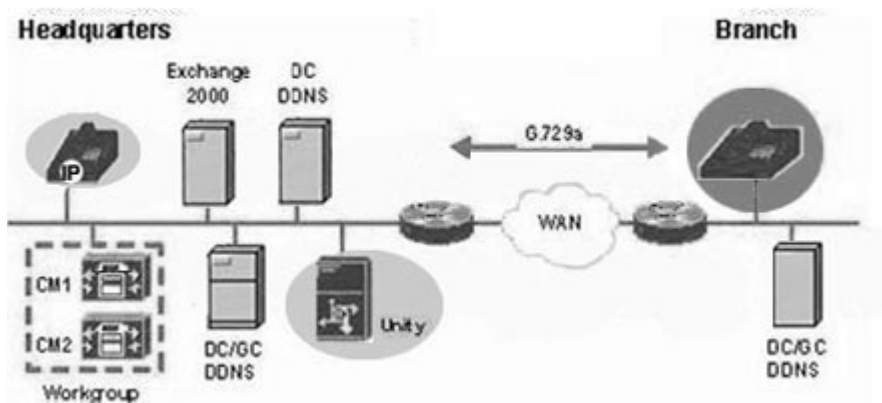

Certkiller .com has a remote branch with 50 telephones. There are no hardware transcoders on the routers.

With the configuration as presented, which statement is true about codec use on the Cisco Unity?

- A. Cisco Unity should be set to use G729a.
- B. Cisco Unity should always use G711 for messages.
- C. Cisco Unity should use G729a for messages and G711 for prompts.
- D. Cisco Unity's codec must always be matched to CallManager in centralized messaging deployments.

Answer: A

QUESTION 180:

Exhibit

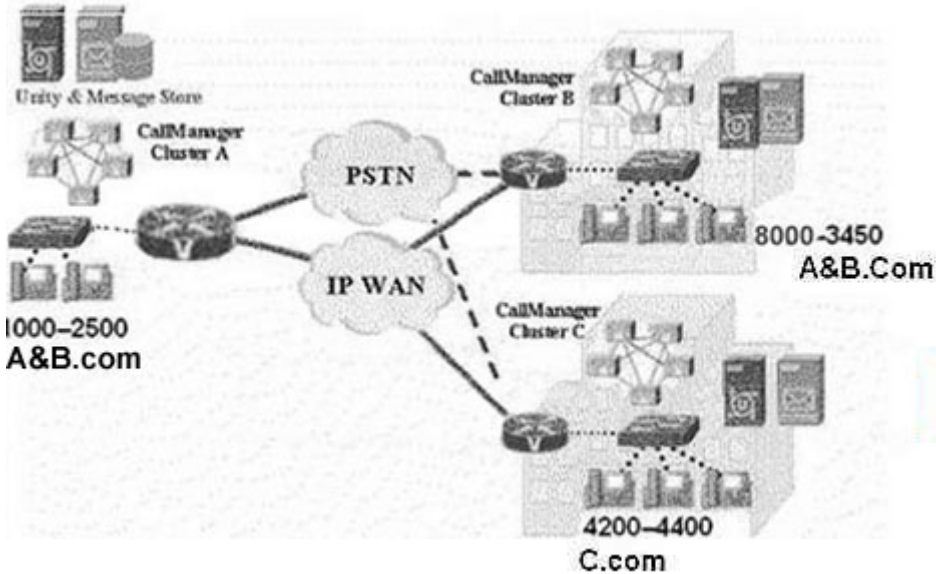

CallManager Cluster A and Unity use extension range 1000-2500. CallManager Cluster B and Unity use extension range 3000-3450. CallManager Cluster C and Unity use extension range 4200-4400.

Your customer Certkiller .com wants to deploy Unified Messaging. Exchange stores are local at the data center. Digital networking is an absolute requirement without using access codes.

What is the best solution?

- A. Site C needs to have all the servers reinstalled as part of A&B.com.
- B. A unique dialing domain is created per Unity location. There is no requirement for one directory.
- C. A completely unique "dialing location" is created in CallManager. Unity is assigned to that location.
- D. Future growth is planned for by allowing all Unity servers to be in different forests, but be part of the same dialing domain.

Answer: A

QUESTION 181:

Exhibit

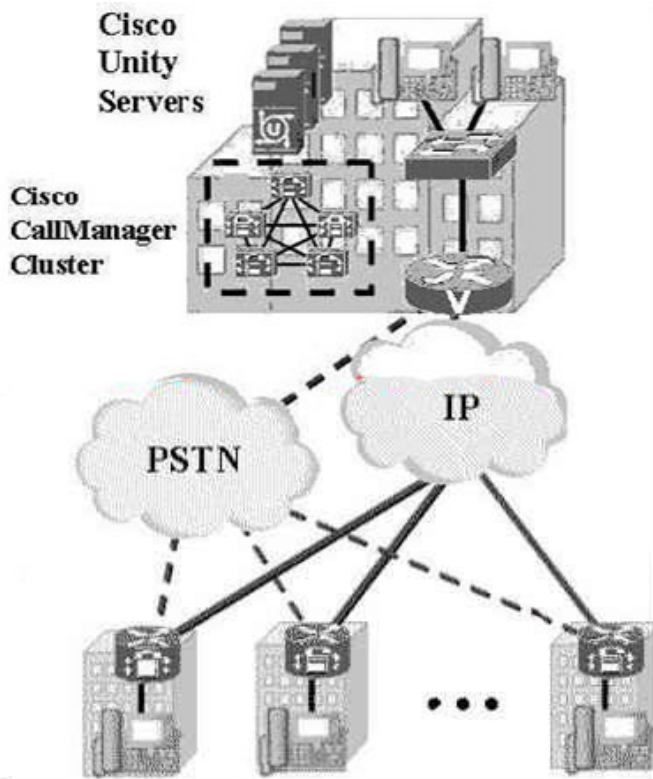

Hardware transcoding is being provided at the main site. All remote telephones are in a G.729 region. Customers complain that audio quality is poor at times. What could be the cause of this problem?

- A. Unity is using G.726 for system prompts and G.711 for message store format.
- B. Hardware transcoding has been disabled in the network so no conversion is taking place for the remote users.
- C. Unity has G.729 disabled and the hardware transcoding is degrading the audio quality before the call reaches Unity because the message store format is different.
- D. Unity is using G.711 for the message store and system prompts. All G.729 calls are going directly to Unity to be converted and therefore the audio quality is degraded.

Answer: D

QUESTION 182:

Certkiller .com maintains a wholly centralized electronic messaging environment in a single data center, physically located in Denver. The customer uses Microsoft Exchange exclusively, and at this time has a distributed, Cisco CallManager environment consisting of three separate clusters. These clusters support the Denver data center plus three large remote sites in Colorado Springs, Boulder and Montrose.

Certkiller .com's plans call for moving from their centralized, 10 year old Legacy voice mail system to a Unified Messaging system. You offer Cisco Unity as a potential solution.

Given the Certkiller .com's topology for call processing and messaging, what is your recommendation?

- A. You recommend centralized and distributed Unity servers. There are many choices available to you because of the inherent call processing flexibility built into a pure Cisco CallManager design. You recommend a hybrid solution to demonstrate to the customer the flexibility of the product.
- B. You cannot provide an initial design at this time. The customer's need for three Cisco CallManager clusters has brought the design process to a standstill. You MUST go back and convince the customer to fully collapse the CallManager clusters for Cisco Unity to fit into their environment.
- C. You recommend centralized Unity systems. Unity MUST reside as physically close as possible to the message stores it will be servicing. Also, since Cisco Unity servers are capable of servicing more than one Cisco CallManager cluster, you decide to offer a centralized messaging and distributed call processing design.
- D. You recommend distributed Unity systems. Unity MUST reside as physically close as possible to the CallManager clusters, and Cisco Unity servers MUST maintain a one-to-one relationship to the number of CallManager clusters in the design. At a minimum, you must provide a three Cisco Unity solution, and they must be distributed to physically mirror the layout of the Cisco CallManager topology.

Answer: C

QUESTION 183:

Exhibit

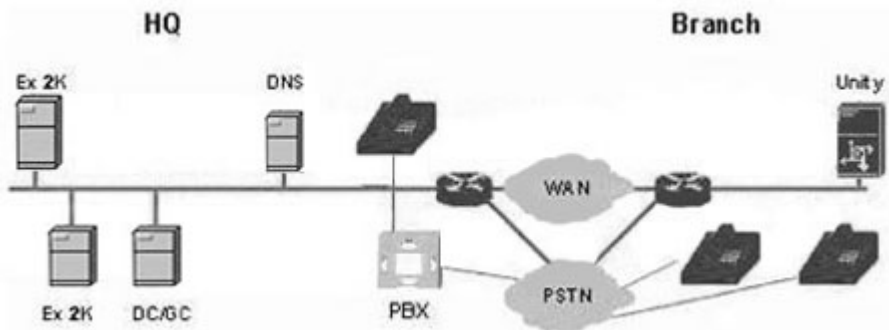

Which type of Cisco Unity deployment model is shown in the exhibit?

- A. The exhibit does not show a valid model combination.
- B. centralized call processing, distributed messaging
- C. distributed call processing, decentralized messaging
- D. localized call processing, localized branch messaging.

Answer: A

QUESTION 184:

Exhibit

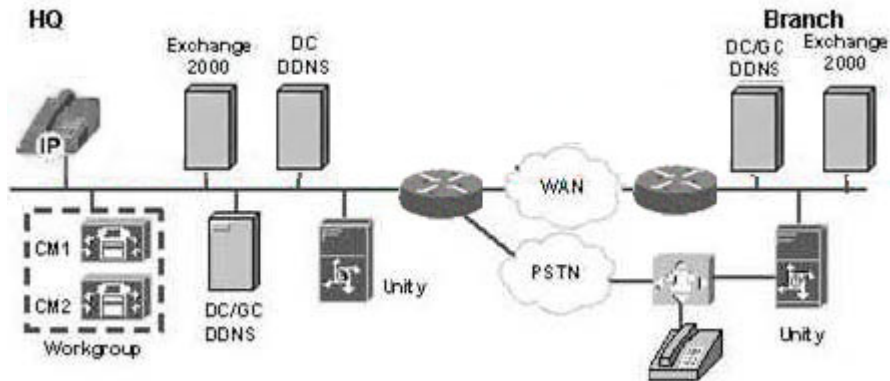

Certkiller .com's messaging topology is shown in the exhibit.
Which Cisco Unity messaging deployment model is illustrated?

- A. branched messaging
- B. single site messaging
- C. distributed messaging
- D. centralized messaging

Answer: C

QUESTION 185:

Your customer Certkiller .com has a distributed messaging deployment model. All messaging infrastructure components are also distributed. If Unity will service Lotus Domino and Notes, all the messaging infrastructure components that Domino and Unity need should be collocated with them.

For Domino and Unity, which infrastructure components are necessary?

- A. At least one Domino domain level address book (names.nsf) server, one Domino partitioned message server, and Notes clients are necessary. DNS resolution must be properly configured in the Domino environment.
- B. At least one Domino directory synchronization server, one Domino partitioned message server, and Notes clients are necessary. Clustering must be fully enabled on all local mail stores and DNS resolution must be properly configured in the Domino environment.
- C. At least one Domino domain level address book (names.nsf) server, one Domino mail store server, and Notes clients are necessary. DNS resolution must be properly configured in the Domino environment. Cisco Unity must be a member of a Windows domain as well.
- D. At least one Domino directory synchronization server, one Domino partitioned message server, and Notes clients are necessary. DNS resolution must be properly configured in the Domino environment. Cisco Unity must be a member of an Active Directory domain.

Answer: C

QUESTION 186:

You meet with a customer, Certkiller .com, who is currently collapsing their IBM/Lotus Notes environment from a multi-site distributed layout to a single data center in Indianapolis. With offices across the United States, (35 of them), and a distributed mix of Legacy non-networked PBXs, you have a very complex environment to try and converge?

Certkiller .com also maintains a wholly distributed Legacy voice mail environment, but wants to treat the data center as a completely new installation with no existing infrastructure with regard to voice mail, and as such is very flexible with voice mail migration options.

When you explain some of the potential technical options given their existing environment, they agree that a Cisco CallManager/Cisco Unity solution is optimal. They have a limited budget this fiscal year, and need to slowly move from this distributed PBX/Electronic Messaging layout to a Cisco solution over the next two years.

What do you recommend to the customer?

A. You offer them centralized Unity for Exchange as a voice mail replacement, since their Notes infrastructure is distributed. Since Unity for Domino CANNOT fit in this environment for a number of reasons, this is their only option.

B. You cannot help them today, since moving slowly will not work given the need to perform zip and replace? Of PBXs at each of the remote sites. Unity simply cannot fit into their current environment. If they had the budget to perform zip and replace? Then you could help them.

C. You offer them distributed Unity servers on the edge, since Unity MUST reside as physically close as possible to the Legacy PBXs. You put the CallManager rollout on hold as well, until the customer has the funds necessary to support a zip and replace? Strategy for the Legacy PBXs. Distributed Unity servers will also be able to better support the migration strategy you know they need for their centralized voice mail servers. In your next meeting, you MUST discuss the voice mail replacement/migration strategy with the customer.

D. Since they are very flexible with the pathway you lead them to, you offer an initial centralized Unity server layout. Since they will be collapsing at least some of their PBXs to a CallManager layout, and they will be fully centralizing their Notes Messaging infrastructure, you have the initial Cisco Unity servers in the data center service those users who will be on the first round? of migration from the legacy PBXs to the centralized CallManagers. Over time you will add Unity servers as needed to support the customer's timelines and budget. Cisco Unity can even support a dual PBX? integration in the data center, if needed.

Answer: D

QUESTION 187:

In a Cisco Unity voice messaging only configuration will fallover, how many Exchange 2000 routing groups are needed if all Exchange 2000 servers are centralized into one data center, but all users are remotely connected?

- A. You need only one routing group.
- B. You need one routing group for each remote location.
- C. It is more important to install Unity into the same Windows 2000 site and remote routing group.
- D. It depends on how the remote users are connected to Unity. If they are using IMAP, they should be able to use any number of routing groups.

Answer: A

QUESTION 188:

Is it possible for Unity to connect to the same global catalog server as the Exchange 2000 server it is servicing, if Unity is installed in its own Windows 2000 site?

- A. No, it is not possible because a global catalog server can only service one Windows 2000 site.
- B. No, it is not possible because the Exchange 2000 servers replicate too much directory information.
- C. Yes it is possible as long as you edit the registry and point Unity to the correct global catalog server.
- D. Yes it is possible because a global catalog server can be configured to support up to five Windows 2000 sites.

Answer: A

QUESTION 189:

Exhibit

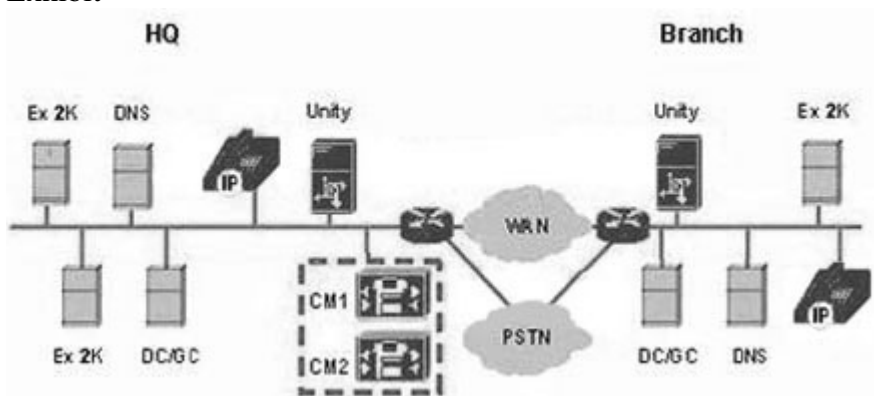

Which Cisco Unity type of deployment model is shown in the exhibit?

- A. centralized call processing, distributed messaging
- B. centralized call processing, centralized messaging

- C. distributed call processing, decentralized messaging
- D. localized call processing, localized branch messaging

Answer: A

QUESTION 190:

Certkiller .com maintains a distributed Legacy voice mail and messaging infrastructure. They also have a distributed call processing environment, consisting of Legacy PBX equipment.

Certkiller .com maintains a dual data center layout in San Diego, California and Yuma, Arizona with two smaller remote branch offices in Palm Springs and El Centro, California, connected to the data centers by 256k links. There are at least 500 users in both remote sites, with 2000 users in each data center.

Certkiller .com wants to move from their Legacy voice mail system to a Unified Messaging environment with Cisco Unity. You discuss options for collapsing the company's call processing infrastructure as well and find they cannot collapse their Legacy call processing environment to centralized Cisco CallManager. They must keep the Legacy PBXs functioning for at least two more years as stipulated by their lease agreement.

You request all PBX type/release information from the customer and discover that their current PBXs are all supported by Cisco Unity. The PBX's are all from the same manufacturer, and 5 digit dialing is available from any phone in their network.

Given that 5 digit dialing is available from any phone on the customer's network, which statement is true?

- A. They do not need to enable more networking? on their PBXs
- B. They can begin to collapse their call control environment to line up with the introduction of CallManager into their environment.
- C. This means absolutely nothing to this design. Anytime you have remote offices that have mail stores across slow WAN links you MUST have a Unity server collocated with those stores.
- D. They can centralize Unity in a single site. A single Unity can be installed in one of the data centers and can easily support 5000 total users. Since they have 5 digit dialing across their environment, the PBX's networking functions can take care of MWI's, etc.

Answer: C

QUESTION 191:

Exhibit

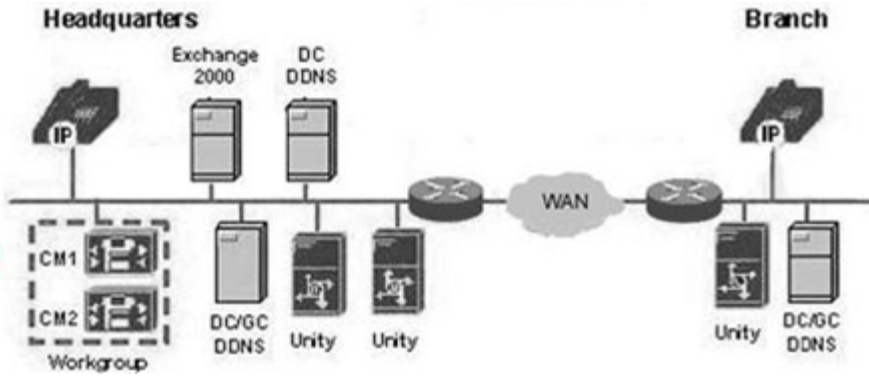

Why is the Cisco Unity deployment shown in the exhibit NOT supported?

- A. Digital networking will not work over the WAN.
- B. There are two Cisco Unity servers installed at headquarters.
- C. A Cisco CallManager cluster is required at the branch office.
- D. The Cisco Unity branch office server is remote from a message store.

Answer: D

QUESTION 192:

Exhibit #1

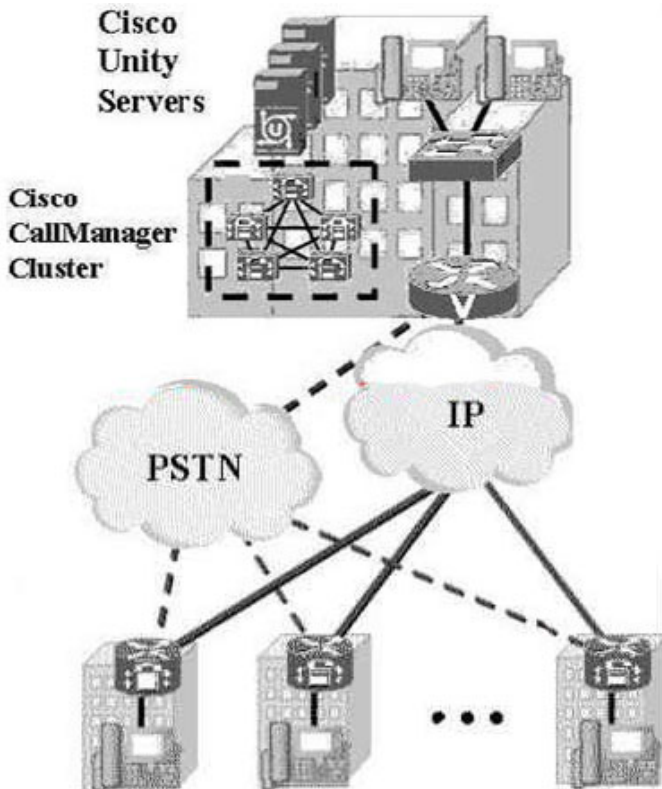
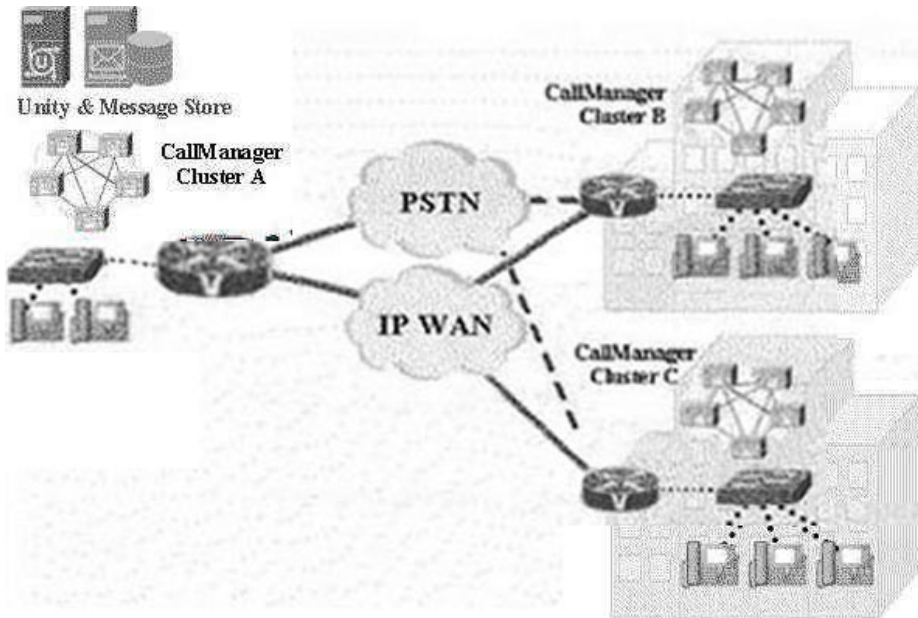

Exhibit #2



In Exhibit 1, the CallManager cluster and Unity use the extension range 3000-4200. Your customer Certkiller.com wants to deploy Unified Messaging. Exchange stores are local at the data center and are part of the same organization. Digital networking is an absolute requirement without using access codes. Exhibit 2 shows how the IT organization expects to accommodate future growth. What is the best solution with regard to dialing domains?

- A. A completely unique "dialing location" is created in CallManager and Unity is assigned to that location.
- B. All Unity servers need to be in the same dialing domain. This poses no problem given its simple environment.
- C. A unique dialing domain is created at each Unity location. The other Unity locations are automatically available at that time.
- D. Future growth is planned for by allowing all Unity servers to be in different locations and to be part of separate dialing domains.

Answer: B